



**San Francisco  
County Transportation  
Authority**

BD071222

RESOLUTION NO. 23-05

---

RESOLUTION ACCEPTING THE PENNSYLVANIA AVENUE EXTENSION PROJECT  
INITIATION REPORT

WHEREAS, In 2018, the San Francisco Planning Department, in partnership with the Transportation Authority and other partner agencies, concluded the Railyard Alignment and Benefits (RAB) Study; and

WHEREAS, The RAB Study assessed options for the alignment of the Caltrain corridor through San Francisco and identified the City's preferred alignment as a tunnel beneath 7<sup>th</sup> Street and Pennsylvania Avenue, which would connect directly to the Downtown Rail Extension (DTX) and extend the below-grade rail alignment southward; and

WHEREAS, In September 2018, through approval of Resolution 19-12, the Transportation Authority Board adopted the 7<sup>th</sup> Street to Pennsylvania Avenue alignment as the preferred configuration for grade separating the Caltrain corridor south of the DTX; and

WHEREAS, The Pennsylvania Avenue Extension (PAX) project will grade-separate existing Caltrain and future California High-Speed Rail passenger rail operations from local vehicular and pedestrian traffic patterns at Mission Bay Drive and 16<sup>th</sup> Street, removing barriers between the Mission Bay and Potrero Hill neighborhoods; and

WHEREAS, In November 2019, through approval of Resolution 20-16, the Transportation Authority Board appropriated \$1.6 million in Prop K sales tax funds for the PAX Project Initiation Study (Study), to develop viable PAX alternatives to advance into the subsequent phases of planning and environmental review; and

WHEREAS, In June 2020, through approval of Resolution 20-55, the Transportation Authority Board awarded a consulting contract to McMillen Jacobs Associates to undertake the PAX Project Initiation Study's technical work program; and



**San Francisco  
County Transportation  
Authority**

BD071222

RESOLUTION NO. 23-05

---

WHEREAS, The Transportation Authority staff conducted the Study with the consultant team and with the support and input of partner agencies, including Caltrain, California High-Speed Rail Authority, the Transbay Joint Powers Authority, Caltrans, and multiple City departments; and

WHEREAS, The Study developed a range of alternatives and undertook a technical evaluation process to screen and evaluate alternatives through design development, technical analysis, risk assessment, cost estimation, partner input, and third-party peer review; and

WHEREAS, The Study developed three feasible alignment alternatives, including long, mid-length, and short tunnel alternatives, reflecting differing approaches to alignment configuration, tunnel design, and impacts to the existing 22<sup>nd</sup> Street Caltrain Station; and

WHEREAS, Long Alternative A would provide a tunneled rail alignment from DTX to a point immediately north of Cesar Chavez Street, bypassing the existing 22<sup>nd</sup> Street Caltrain Station and requiring relocation of the existing station; and

WHEREAS, Mid-Length Alternative B would provide a tunneled rail alignment from DTX to a point immediately north of the existing 22<sup>nd</sup> Street Caltrain Station, requiring modifications to the existing station and an interface with existing Caltrain tunnels; and

WHEREAS, Short Alternative C would provide separated southbound and northbound tunnels, resulting in an interface point north of the existing 22<sup>nd</sup> Street Caltrain Station and in a more significant impact on corridor operations during construction.

WHEREAS, The Study developed planning-level capital cost estimates and schedules for the three PAX alternatives; and

WHEREAS, The estimated capital cost of these alternatives is approximately \$2.0-2.5 billion, excluding potential costs to relocate or modify the existing 22<sup>nd</sup> Street Station; and



**San Francisco  
County Transportation  
Authority**

BD071222

RESOLUTION NO. 23-05

---

WHEREAS, Development and implementation of PAX will require a minimum of approximately 12-15 years, in order to complete further planning, environmental review, design, procurement, and construction; and

WHEREAS, The Study was developed in parallel to the San Francisco Planning Department's Southeast Rail Station Study (SERSS), which considered potential future station locations along the PAX alignment; and

WHEREAS, The next phase of PAX work will incorporate the SERSS work to date, in order to incorporate station design and cost considerations into the further refinement and evaluation of PAX alternatives; and

WHEREAS, The Study recommends the PAX Pre-Environmental Study as a next step, to prepare for future environmental review by identifying the most viable alternatives and developing the organizational and technical approach to the environmental phase; and

WHEREAS, The attached PAX Initiation Report documents Study activities and analysis and presents Study findings and recommendations; now, therefore, be it

RESOLVED, That the Transportation Authority hereby accepts the PAX Project Initiation Report; and be it further

RESOLVED, That the Executive Director is hereby authorized to prepare the document for final publication and distribute the document to all relevant agencies and interested parties.

Attachment:

1. PAX Project Initiation Report - Draft



**San Francisco  
County Transportation  
Authority**

BD071222

RESOLUTION NO. 23-05

The foregoing Resolution was approved and adopted by the San Francisco County Transportation Authority at a regularly scheduled meeting thereof, this 26th day of July 2022, by the following votes:

**Ayes:** Commissioners Chan, Dorsey, Mandelman, Mar, Melgar, Peskin, Preston, Safai, and Walton (9)

**Nays:** (0)

**Absent:** Commissioners Ronen and Stafani (2)

DocuSigned by:  
*Rafael Mandelman* 8/23/2022  
3235B3A057A3450...

Rafael Mandelman Date  
Chair

DocuSigned by:  
*Tilly Chang* 8/24/2022  
FFD2528AB8BE49B...

ATTEST:

Tilly Chang Date  
Executive Director



# Pennsylvania Avenue Extension Study

## Project Initiation Report (Draft)



Report Date: June 2022

*This page intentionally left blank*

# Table of Contents

|   |           |
|---|-----------|
| <b>Abbreviations and Acronyms .....</b>                                     | <b>ix</b> |
| <b>Executive Summary .....</b>  | <b>1</b>  |
| <b>1.0 Project Purpose and Goals .....</b>                                  | <b>5</b>  |
| 1.1 Introduction .....  | 5         |
| 1.2 Project Description .....   | 6         |
| 1.3 Project History .....   | 7         |
| 1.4 Existing Rail System Within Project Area .....                          | 7         |
| 1.5 Project Goals .....   | 8         |
| 1.6 Stakeholder Participation .....   | 8         |
| 1.7 Report Authors .....  | 9         |
| <b>2.0 Alternatives Definition .....</b>                                    | <b>10</b> |
| 2.1 Description of Alternatives .....                                       | 10        |
| 2.1.1 Alternative A1: Long Alignment – Single Bore Tunnel .....             | 10        |
| 2.1.2 Alternative A2: Long Alignment – Twin Bore Tunnels .....              | 10        |
| 2.1.3 Alternative B1: Mid-Length Alignment – Single Bore + SEM Tunnel ..... | 11        |
| 2.1.4 Alternative B2: Mid-Length Alignment – Twin Bore + SEM Tunnels .....  | 12        |
| 2.1.5 Alternative C: Short Alignment – Split Tunnels .....                  | 13        |
| 2.1.6 Alternatives D, E, and F .....  | 14        |
| <b>3.0 Alternatives Evaluation .....</b>                                    | <b>16</b> |
| 3.1 Alignment Validation Process .....                                      | 16        |
| 3.2 Alignment Alternatives Screened Out .....                               | 16        |
| 3.3 Evaluation Framework Matrix .....                                       | 17        |
| 3.4 Overview of the PAX Evaluation Framework Matrix .....                   | 17        |
| 3.5 Evaluation Methodology .....  | 18        |
| 3.5.1 Project Goals .....   | 18        |
| 3.5.2 Project Interfaces .....  | 20        |
| 3.5.3 Construction Impacts .....  | 21        |
| 3.5.4 Environmental Impacts .....   | 22        |
| 3.5.5 Programming .....   | 25        |
| 3.6 Analysis Results .....  | 26        |
| 3.6.1 Alternative A1: Long Alignment – Single Bore Tunnel .....             | 27        |
| 3.6.2 Alternative A2: Long Alignment – Twin Bore Tunnels .....              | 28        |

|            |  |           |
|------------|--|-----------|
| 3.6.3      | Alternative B1: Mid-Length Alignment – Single Bore + SEM Tunnels ..... | 28        |
| 3.6.4      | Alternative B2: Mid-Length Alignment – Twin Bore + SEM Tunnels.....    | 29        |
| 3.6.5      | Alternative C: Short Alignment – Split Tunnels .....                   | 30        |
| 3.7        | Alternatives Evaluation Summary .....                                  | 31        |
| <b>4.0</b> | <b>Rail Operations and Interfaces .....</b>                            | <b>33</b> |
| 4.1        | System Capacity .....  | 33        |
| 4.2        | Caltrain Operations .....  | 33        |
| 4.3        | HSR Operations.....  | 34        |
| 4.4        | Downtown Rail Extension (DTX) .....                                    | 35        |
| 4.5        | Railyards .....  | 35        |
| 4.6        | Rail Service Implementation .....                                      | 37        |
| 4.6.1      | Alternative A1/A2 – Long Alignment .....                               | 38        |
| 4.6.2      | Alternative B1/B2 – Mid-Length Alignment .....                         | 38        |
| 4.6.3      | Alternative C – Short Alignment .....                                  | 39        |
| <b>5.0</b> | <b>Rail Infrastructure and Systems .....</b>                           | <b>41</b> |
| 5.1        | Fire/Life Safety and Ventilation.....                                  | 41        |
| 5.2        | Traction Power Electrification .....                                   | 43        |
| 5.3        | Communication .....  | 43        |
| 5.4        | Track and Switches.....  | 44        |
| <b>6.0</b> | <b>Geotechnical and Hydrology.....</b>                                 | <b>45</b> |
| 6.1        | Geotechnical Study and Tunneling Considerations.....                   | 45        |
| 6.1.1      | Approach .....   | 45        |
| 6.1.2      | Summary of Findings .....  | 45        |
| 6.1.3      | Geologic Constraints and Considerations.....                           | 48        |
| 6.1.4      | Tunneling Considerations .....   | 48        |
| 6.2        | Hydrology .....  | 49        |
| 6.2.1      | Approach .....   | 49        |
| 6.2.2      | Summary of Findings .....  | 50        |
| <b>7.0</b> | <b>Tunneling and Constructability .....</b>                            | <b>51</b> |
| 7.1        | Construction Methods .....   | 51        |
| 7.1.1      | Tunneling Methods.....   | 51        |
| 7.1.2      | Cross Passages .....   | 54        |
| 7.1.3      | Track Crossover Sections .....   | 55        |
| 7.1.4      | Portals .....  | 57        |
| 7.1.5      | Ventilation and Emergency Egress Shafts.....                           | 58        |
| 7.1.6      | Building Protection and Ground Instrumentation Monitoring .....        | 58        |



|             |   |           |
|-------------|---|-----------|
| 7.1.7       | Staging Areas and Site Access.....  | 59        |
| 7.2         | Construction Sequence and Constructability Issues for Each Alternative..... | 59        |
| 7.2.1       | Alternative A1.....   | 60        |
| 7.2.2       | Alternative A2.....   | 65        |
| 7.2.3       | Alternative B1.....   | 69        |
| 7.2.4       | Alternative B2.....   | 72        |
| 7.2.5       | Alternative C.....  | 73        |
| <b>8.0</b>  | <b>Existing Utilities .....</b>   | <b>76</b> |
| 8.1         | Methodology .....   | 76        |
| 8.2         | Findings.....   | 76        |
| 8.3         | Anticipated Significant Relocations.....                                    | 78        |
| <b>9.0</b>  | <b>Right-of-Way and Property Issues .....</b>                               | <b>79</b> |
| 9.1         | Alignment Alternatives Considered.....                                      | 79        |
| 9.2         | Property Identification .....   | 79        |
| 9.3         | Property Valuation .....  | 79        |
| 9.4         | Property Impacts.....   | 80        |
| 9.5         | Construction Staging Areas .....  | 81        |
| 9.6         | Summary of Alternative Impacts.....   | 82        |
| <b>10.0</b> | <b>Project Risks.....</b>   | <b>83</b> |
| 10.1        | Approach.....   | 83        |
| 10.2        | Findings.....   | 84        |
| <b>11.0</b> | <b>Project Schedule and Costs.....</b>                                      | <b>87</b> |
| 11.1        | Approach.....   | 87        |
| 11.2        | Cost.....   | 88        |
| 11.3        | Schedule .....  | 88        |
| <b>12.0</b> | <b>Environmental, Cultural, and Historic Studies.....</b>                   | <b>90</b> |
| 12.1        | Findings of Studies Completed.....  | 90        |
| 12.1.1      | Traffic .....   | 90        |
| 12.1.2      | Air Quality.....  | 90        |
| 12.1.3      | Noise and Vibration .....   | 93        |
| 12.1.4      | Archaeological Resources .....  | 98        |
| 12.1.5      | Cultural and Historic Resources.....  | 100       |
| 12.2        | Hazards and Hazardous Materials .....                                       | 104       |
| 12.2.1      | Alternative A1.....   | 106       |
| 12.2.2      | Alternative A2.....   | 106       |

|             |  |            |
|-------------|--|------------|
| 12.2.3      | Alternative B1 .....                                       | 106        |
| 12.2.4      | Alternative B2 .....                                       | 106        |
| 12.2.5      | Alternative C .....  | 107        |
| 12.3        | Environmental Justice .....                                | 107        |
| 12.3.1      | Alignment A1 .....   | 107        |
| 12.3.2      | Alignment A2 .....   | 108        |
| 12.3.3      | Alignment B1 .....   | 108        |
| 12.3.4      | Alignment B2 .....   | 109        |
| 12.3.5      | Alignment C .....  | 109        |
| 12.4        | Major Issues .....   | 109        |
| 12.5        | Approval and Next Steps .....                              | 110        |
| <b>13.0</b> | <b>Permitting .....</b>                                    | <b>111</b> |
| 13.1        | Encroachment Permits .....                                 | 111        |
| 13.2        | Air Quality Permits .....                                  | 111        |
| 13.3        | Water Quality and Discharge Permits .....                  | 111        |
| 13.4        | Noise Permits .....  | 112        |
| 13.5        | Cultural Resources Consultations .....                     | 112        |
| <b>14.0</b> | <b>Recommendations for Further Technical Studies .....</b> | <b>113</b> |
| 14.1        | General .....  | 113        |
| 14.2        | Environmental .....  | 113        |
| 14.3        | Traffic .....  | 113        |
| 14.4        | Geotechnical .....   | 113        |
| 14.5        | Tunneling .....  | 114        |
| 14.6        | Existing Utilities and Infrastructure .....                | 114        |
| 14.7        | Rail/Systems .....   | 114        |
| 14.8        | ROW/Property .....   | 115        |
| 14.9        | Risk .....   | 115        |
| <b>15.0</b> | <b>Conclusion .....</b>                                    | <b>116</b> |
| <b>16.0</b> | <b>References .....</b>                                    | <b>119</b> |

## List of Tables

|  |    |
|--|----|
| Table ES-1. Cost Estimate Summary for Each of the Alternatives ..... | 3  |
| Table 3-1. Evaluation Framework .....                                | 17 |
| Table 3-2. Evaluation Framework with Scoring .....                   | 26 |

|  |     |
|--|-----|
| Table 3-3. Alignment Alternative Features (from Alternatives Analysis Report)..... | 32  |
| Table 9-1. Construction Staging Area Cost Estimate .....                           | 81  |
| Table 9-2. Summary of ROW Impacts .....  | 82  |
| Table 10-1. Risk Scoring Matrix .....  | 84  |
| Table 10-2. “High” Scored Risks by Alignment Alternative .....                     | 85  |
| Table 11-1. Cost of Station Configuration and Components by Alternative .....      | 88  |
| Table 11-2. Project Schedule Summaries for Alternatives .....                      | 89  |
| Table 15-1. Preliminary Evaluation Score Results for Alternatives .....            | 116 |

## List of Figures

|   |    |
|---|----|
| Figure 1-1. PAX Index Map Showing Corridor, Relationship with DTX, and Stations .....   | 6  |
| Figure 2-1. Long Alignment – Single Bore Tunnel. Rail and Existing Caltrain Tunnels noted. See also Appendix B. ....  | 10 |
| Figure 2-2. Long Alignment – Twin Bore Tunnels. Rail and Existing Caltrain Tunnels noted. See also Appendix B. ....   | 11 |
| Figure 2-3. Mid-Length Alignment – Single Bore + SEM Tunnel. Rail and Existing Caltrain Tunnels Noted. See also Appendix B. ....  | 12 |
| Figure 2-4. Mid-Length Alignment – Twin Bore + SEM Tunnels. Rail and Existing Caltrain Tunnels Noted. See Appendix B. ....  | 13 |
| Figure 2-5. Short Alignment – Split Tunnels. Rail and Existing Caltrain Tunnels Noted. See also Appendix B. ....  | 14 |
| Figure 4-1. Surface Railyard Access Schematic for Alternative A1/A2 .....   | 37 |
| Figure 4-2. Alternative B1/B2: PAX Commissioning and Revenue Service .....  | 39 |
| Figure 4-3. Alternative C: PAX Commissioning and Revenue Service .....  | 40 |
| Figure 5-1. Fire/Life Safety Features for Long Alignment – Single Bore Tunnel .....   | 41 |
| Figure 5-2. Fire/Life Safety Features for Long Alignment – Twin Bore Tunnels.....   | 41 |
| Figure 5-3. Fire/Life Safety Features for Mid-Length Alignment – Single Bore + SEM Tunnel .....   | 41 |
| Figure 5-4. Fire/Life Safety Features for Mid-Length Alignment – Twin Bore + SEM Tunnels.....   | 42 |
| Figure 5-5. Fire/Life Safety Features for Short Alignment – Split Tunnels .....   | 42 |
| Figure 6-1. Index Map of Corridor Segments.....   | 46 |
| Figure 7-1. EPB TBM (source: Herrenknecht).....   | 52 |
| Figure 7-2. SEM Construction Example, Showing Pipe Support Over Tunnel Crown and Sequentially Excavated Tunnel Drifts (Beacon Hill Station, Sound Transit, Seattle) ..... | 53 |

|  |    |
|--|----|
| Figure 7-3. Example of a 3D Rendering of a Cross Passage between Two Running Tunnels for a Subway (Northlink, Sound Transit) .....   | 55 |
| Figure 7-4. Example of SEM Mining of Center Area between Two Running Tunnels to Create Space for a Track Crossover Section (TJPA, 2017) .....  | 56 |
| Figure 7-5. Example of a Track Crossover Section under Construction in Central Subway, San Francisco (SFMTA, 2016) .....   | 56 |
| Figure 7-6. Examples of Single and Multitrack Portals .....  | 57 |
| Figure 7-7. Example of a TBM Set Up and Ready to Excavate into a Headwall (46-foot-diameter TBM, Waterview, NZ).....   | 60 |
| Figure 7-8. PAX TBM Launch Chamber near Interface with DTX (gray area), Showing Interference with Existing Caltrain Tracks (blue).....   | 61 |
| Figure 7-9. Area Where PAX Alignment (gray) Crosses Existing Division Street Box Sewer (red) and Future Folsom Street Sewer (red).....   | 62 |
| Figure 7-10. Geologic Profile Showing Soil Units Relative to PAX Profile at North End of Tunnel (refer to legend, right) .....   | 63 |
| Figure 7-11. Area of PAX Alignment Where Mixed Soil/Rock Conditions are Anticipated to Occur (refer to legend, above).....   | 63 |
| Figure 7-12. Area of PAX Alignment with Low Ground Cover (refer to legend, above) .....  | 63 |
| Figure 7-13. South Portal Area for the Alternative A1 Alignment, Showing Potential New Portal Area, Conceptual Footprint of a Ventilation Structure, and Track Tie-in to Existing Caltrain Rail..... | 64 |
| Figure 7-14. Simplified Cross Section of a Single Bore Tunnel Showing Dimensions Assumed for Cost Estimating in this Study.....  | 65 |
| Figure 7-15. Area on 7th Street Where the Two Twin Bore Tunnels are Indicated to be within 5 Feet of Each Other .....  | 66 |
| Figure 7-16. Example of Footprint Required for Jet Grout Operations from Surface and Associated Traffic Control (LA Metro Purple Line) .....   | 67 |
| Figure 7-17. One of the Proposed Exit/Vent Shaft Locations for Alternative A2 .....  | 68 |
| Figure 7-18. Simplified Cross Section of a Tunnel for the Twin Bore Option (Alternative A2) Showing Dimensions Assumed for Cost Estimating in this Study .....                                       | 69 |
| Figure 7-19. Plan and Profile of the SEM-mined Connections from the South End of a Single Bore Tunnel to existing Caltrain Tracks for Alternative B1 .....   | 70 |
| Figure 7-20. 3D Rendering of the Tunnel Connections from TBM Bored Tunnel (upper left) to Existing Caltrain Tracks/Tunnel (right).....   | 71 |
| Figure 7-21. Improvements Necessary at 22nd Street Station for Alternatives B1 and B2.....   | 72 |
| Figure 7-22. Plan and Profile of the Twin TBM Bored Tunnel Connections to Existing Caltrain Tracks for Alternative B2.....   | 73 |

Figure 7-23. Interference Issues Pertaining to the Cut-and-Cover Section for Alternative C PAX Alignment (red). Division Street Box Sewer (brown), Berry Street (green), and Relocation of Existing I-280 column (yellow). ..... 74

Figure 7-24. Interference and Connection Details in the 17th Street and Mariposa Street Area of Alternative C. New Cut-and-Cover Tunnel (red), TBM Bored Tunnel (gray), Relocated I-280 Columns (yellow), and Existing Caltrain Tunnel No. 1..... 75

Figure 9-1. Federal Reserve Property Price Index for Condominiums (source: Federal Reserve Bank, St. Louis) ..... 80

Figure 10-1. Summary of Risk Scores by Alignment Alternative ..... 86

## Distribution

To: Yana Waldman, PE  
San Francisco County Transportation Authority

Jesse Koehler  
San Francisco County Transportation Authority

From: Sarah Wilson, PE  
McMillen Jacobs Associates

Prepared By: John Kaplin, CEG  
McMillen Jacobs Associates

Tom Pennington, PE, P.Eng  
McMillen Jacobs Associates

John Stolz, PE  
McMillen Jacobs Associates

Kush Chohan, PE, GE  
McMillen Jacobs Associates

Keith Abey, PE, SE  
PGH Wong Engineering, Inc.

Julie Watson  
Environmental Science Associates

Reviewed By: Sarah Wilson, PE  
McMillen Jacobs Associates

Dingxin Cai  
McMillen Jacobs Associates

## Abbreviations and Acronyms

| Abbreviation/Acronym | Term  |
|----------------------|---|
| APEZ                 | Air Pollutant Exposure Zone                       |
| AT&T                 | American Telephone and Telegraph                  |
| BAAQMD               | Bay Area Air Quality Management District          |
| BLS                  | Blue Light Stations                               |
| CHSRA                | California High-Speed Rail Authority              |
| Caltrain             | California Department of Transportation           |
| CCF                  | Central Control Facility                          |
| CCSF                 | City and County of San Francisco                  |
| CCTV                 | Closed Circuit Television                         |
| CEQA                 | California Environmental Quality Act              |
| CHSR                 | California High-Speed Rail                        |
| CWA                  | Clean Water Act                                   |
| dBA                  | A-weighted decibels                               |
| DOT                  | U.S. Department of Transportation                 |
| DTSC                 | California Department of Toxic Substances Control |
| DTX                  | Downtown Rail Extension                           |
| EMU                  | electric multiple units                           |
| EPB TBM              | Earth Pressure Balance Tunnel Boring Machine      |
| ESA                  | Environmental Science Associates                  |
| ESL                  | Environmental Screen Level                        |
| FLS                  | fire/life safety                                  |
| FTA                  | Federal Transit Administration                    |
| HSR                  | High-Speed Rail                                   |
| LNAPL                | light non-aqueous phase liquid                    |
| LOS                  | level of service                                  |
| LUST                 | Leaking Underground Storage Tank                  |
| MJ                   | McMillen Jacobs Associates                        |
| MRI                  | magnetic resonance imaging                        |
| NATM                 | New Austrian Tunnelling Method                    |
| NEPA                 | National Environmental Policy Act                 |
| NFPA                 | National Fire Protection Association              |
| NHPA                 | National Historic Preservation Act, as Amended    |
| NOA                  | naturally occurring asbestos                      |
| NPDES                | National Pollutant Discharge Elimination System   |
| OCII                 | Office of Community Investment and Infrastructure |
| OCS                  | Overhead Catenary Systems                         |
| OD                   | outside diameter                                  |
| PAX                  | Pennsylvania Avenue Extension Project             |
| PAX                  | Pennsylvania Avenue Extension                     |

| Abbreviation/Acronym | Term  |
|----------------------|---|
| PCJPB                | Peninsula Corridor Joint Powers Board           |
| PG&E                 | Pacific Gas and Electric                        |
| RAB                  | Rail Alignment and Benefits                     |
| ROW                  | right-of-way                                    |
| RWQCB                | Regional Water Quality Control Board            |
| RWQCB                | Bay Regional Water Quality Control Board        |
| SEM                  | Sequential Excavation Method                    |
| SFCTA                | San Francisco County Transportation Authority   |
| SFDDBI               | San Francisco Department of Building Inspection |
| SFMTA                | San Francisco Metropolitan Transit Agency       |
| SFPUC                | San Francisco Public Utilities Commission       |
| SHPO                 | State Historic Preservation Office              |
| SOMA                 | South of Market Area                            |
| SPTC                 | soldier piles in tremie concrete                |
| SSIP                 | Sewer System Improvement Program                |
| TAG                  | Technical Advisory Group                        |
| TBM                  | tunnel boring machine                           |
| TCRP                 | Transit Cooperative Research Program            |
| TJPA                 | Transbay Joint Powers Authority                 |
| TPH-G                | total petroleum hydrocarbons as gasoline        |
| TPHPD                | trains per hour per direction                   |
| YBM                  | Young Bay Mud                                   |
| TRP                  | Transportation Research Board                   |



## Executive Summary

Alternative rail alignments for the Pennsylvania Avenue Extension Project (PAX project) were studied by SFCTA and its consultants to underground a section of existing at-grade Caltrain rail in the southern part of San Francisco. An adjacent and connected project, the Downtown Rail Extension (DTX), will extend Caltrain and future California High-Speed Rail (CHSR) service from the existing 4th Street and King Railyard to the completed Salesforce Transit Center. DTX is environmentally cleared by the CEQA and NEPA process; PAX is in the planning stage and is not yet environmentally cleared. PAX will extend the tunnel portion of the planned DTX alignment south from the Fourth and Townsend Street Station and is planned to underground the existing at-grade rail crossings at 16th Street and Mission Bay Drive to create new street connections with the Mission Bay District. This Project Initiation Report (PIR) culminates the PAX studies conducted in this phase.

**Section 1.0** describes the purpose and goals of the project. To summarize, PAX is driven by four primary goals:

- Increase Connectivity between Mission Bay, Potrero Hill, and Design District/SOMA Neighborhoods
- Improve Safety of Pedestrian, Bicycle, and Vehicular Traffic on Surface Streets
- Enable Improved Efficiency of Caltrain Operations and Service Planning
- Improve Quality of Life in Surrounding Neighborhoods

The predecessor study to this current work was the 2018 Rail Alignment and Benefits (RAB) Study prepared for the City of San Francisco Planning Department. The RAB Study examined alternative rail alignments to connect the fast-growing South of Market and Mission Bay neighborhoods with the rest of San Francisco. The recommended alternative from the RAB Study was a 1.6-mile-long tunnel from the DTX interface at the 4th and King railyard, down 7th Street and Pennsylvania Avenue, connecting to the existing at-grade Caltrain tracks near Cesar Chavez. This broad alignment was carried forward for further development and refinement through this current pre-environmental phase PAX study.

The initial steps of this PAX study were to collect and analyze existing data on existing and planned rail operations, geotechnical conditions, environmental constraints, traffic impacts, right-of-way impacts, and buried utilities. Caltrain and California High-Speed Rail Authority (CHSRA) requirements and constraints were assessed through meetings with representatives from these agencies. Additional information was collected by meetings and desktop studies. An Evaluation Framework process was implemented to evaluate available data and criteria consistently and uniformly for identified alternatives on a qualitative and semi-quantitative basis.

A total of six alternative configurations were initially identified. The range of alignments is fully described in **Section 2.0** and is summarized as follows:

- Two configurations included a full-length (DTX interface to Cesar Chavez Street) tunnel alignment in either single bore (two tracks in one larger tunnel) or twin bore configuration. This alignment bypasses the existing 22nd Street Station.

- Four of the six are short- and mid-length tunnels that connect the DTX interface to the existing rail alignment at points north of the existing 22nd Street Station, allowing for continued use of the 22nd Street Station and for service to stations at points south. The Southeast Rail Station Study, developed in parallel to this study by the San Francisco Planning Department, studied potential locations for a station or stations in the area.

As a result of the Evaluation Framework analysis, a total of three “shortlisted” alignment alternatives are identified in this pre-environmental Project Initiation Report.

The evaluation of these three alignments using a project-specific Evaluation Framework is presented in this report. Engineering and environmental benefits associated with each, as well as a brief discussion of alignments screened from further study, are documented in **Section 3.0** of this report. The three alignment alternatives are long, mid-length, and short, and some can be built by using either one tunnel or two.

To summarize, the three shortlisted alignments are:

- Alternative A1/A2: Long Alignment – Single Bore/Twin Bore Tunnels
- Alternative B1/B2: Mid-Length Alignment – Single Bore/Twin Bore + SEM Tunnels
- Alternative C: Short Alignment – Split Tunnels

Technical studies on the alignment alternatives selected were conducted. This report summarizes the information and findings of the technical studies, and identifies major benefits and risks associated with each of the recommended alignment alternatives.

**Section 4.0** provides an overview of planned conceptual framework for Rail Operations and Interfaces. Caltrain and CHSRA operations are addressed, and interfaces with DTX and the 4th and King Railyards and associated issues are described. **Section 5.0** defines a conceptual framework for Rail Infrastructure and Systems that will be required for PAX.

Geologic conditions along the PAX corridor will be challenging for tunneling. Soft, weak soils mixed with more competent granular soils are anticipated at the north end of the corridor, transitioning to mixed-face soil and rock towards the center of the corridor. The alignments are in weak and fractured rock with possible mixed-face conditions from the center to south end. **Section 6.0** summarizes geologic and hydrologic conditions.

**Section 7.0** provides a technical evaluation of tunneling and constructability factors that will impact each of the alignments. Single bore configurations are favorable for the available ROW and some rail operational aspects but have the downside of very low ground cover to meet grade restrictions for Caltrain and CHSRA. The twin bore tunnels are difficult to fit side-by-side in the available ROW in the northern portion and have some rail operational downsides but have reduced risk because of increased ground cover. The alternatives that involve undergrounding the rail only north of 22nd Street Station so that the existing station may remain in operation all carry significantly more surface impacts from construction, potential utility interference issues, and challenging tunnel excavation methods where a tunnel boring machine (TBM) cannot be used.

**Section 8.0** examines the existing utilities and infrastructure that will provide constraints to the tunnel alignments. Some of the more challenging issues include the large four-compartment, SFPUC-owned, Division Street box sewer that sits on piles and controls the minimum PAX vertical alignment depth at the crossing. The planned SFPUC Folsom Street Sewer tunnel in the same area will also impact the PAX tunnel depth. Nearly all the alignments are constrained to some degree by deep foundation elements that support the Interstate 280 (I-280) viaduct. Other utilities including advanced relocations are discussed in this section.

A preliminary assessment of right-of-way (ROW) impacts from each of the alignments was conducted. The number of full property acquisitions is limited and ranges from none to four among the alternatives. The greatest impact will be the need for underground property easements. The total ROW property costs for the various alignments are estimated to range from approximately \$20 million to \$150 million. Note that the difference between this estimate and the ROW estimate shown in Table ES-1 reflects the anticipated leasing cost for staging areas during construction, which are included in Table ES-1. **Section 9.0** offers a summary of the ROW impacts of the three alternatives.

Several risk workshops were conducted as part of the PAX study. **Section 10.0** summarizes the approach used in evaluating project risks and findings, and summarizes a scoring of risks for each alternative in three general categories: low, medium, and high. It is expected that risk findings will be carried forward for continued study in future project phases.

Preliminary project schedules, from planning through design and construction, were prepared for each alternative alignment. The alternatives are anticipated to take approximately 12 to 15 years to complete further planning, environmental studies, and construction. The range of estimated construction costs is summarized in Table ES-1. **Section 11.0** addresses schedule and cost.

**Table ES-1. Cost Estimate Summary for Each of the Alternatives**

| Component  | A1 – Long Alignment – Single Bore Tunnel | A2 – Long Alignment – Twin Bore Tunnels | B1 – Mid-Length Alignment – Single Bore + SEM Tunnels | B2 – Mid-Length Alignment – Twin Bore + SEM Tunnels | C – Short Alignment – Split Tunnels |
|--|--|---|---|---|-------------------------------------|
| <b>Construction Costs (2021)<sup>1</sup></b>                       | <b>\$730 M</b>                           | <b>\$780 M</b>                          | <b>\$710 M</b>  | <b>\$700 M</b>                                      | <b>\$690 M</b>                      |
| Construction Midpoint <sup>2</sup>                                 | 10.1 years                               | 10.2 years                              | 10.3 years  | 10.1 years  | 9.5 years                           |
| <b>Escalated Construction Costs<sup>3</sup></b>                    | <b>\$1,200 M</b>                         | <b>\$1,290 M</b>                        | <b>\$1,180 M</b>                                      | <b>\$1,150 M</b>                                    | <b>\$1,100 M</b>                    |
| ROW (2021) <sup>1</sup>  | \$90 M                                   | \$170 M                                 | \$50 M  | \$120 M   | \$40 M                              |
| ROW Acquisition Midpoint   | 3.1 years                                | 3.1 years                               | 3.1 years   | 3.1 years   | 3.1 years                           |
| <b>Escalated ROW Costs<sup>3</sup></b>                             | <b>\$110 M</b>                           | <b>\$200 M</b>                          | <b>\$60 M</b>   | <b>\$140 M</b>                                      | <b>\$50 M</b>                       |
| <b>Soft Costs<sup>4</sup></b>                                      | <b>\$310 M</b>                           | <b>\$310 M</b>                          | <b>\$310 M</b>  | <b>\$310 M</b>                                      | <b>\$310 M</b>                      |
| <b>Contingency</b>   | <b>\$600 M</b>                           | <b>\$650 M</b>                          | <b>\$590 M</b>  | <b>\$580 M</b>                                      | <b>\$550 M</b>                      |
| <b>Total Project Cost</b>  | <b>\$2,220 M</b>                         | <b>\$2,450 M</b>                        | <b>\$2,140 M</b>                                      | <b>\$2,180 M</b>                                    | <b>\$2,010 M</b>                    |
| <b>Total Project Duration</b>                                      | <b>13.3 years</b>                        | <b>13.5 years</b>                       | <b>13.6 years</b>                                     | <b>13.2 years</b>                                   | <b>11.9 years</b>                   |
| <sup>1</sup> Q4 2021 Cost Basis.                                   |  |   |   |   |                                     |
| <sup>2</sup> Based on construction schedule prepared on 2/24/2022. |  |   |   |   |                                     |
| <sup>3</sup> Escalation carried at 5% PA                           |  |   |   |   |                                     |
| <sup>4</sup> Including \$2M Bridging Study                         |  |   |   |   |                                     |

**Section 12.0** provides a summary of findings related to environmental issues. In general, the effects of the PAX project would be temporally limited to project construction, spatially limited to the project corridor,

and could be mitigated with the implementation of a variety of measures. The longer alignments (Alternative A1/A2) would likely result in slightly more impacts because of their overall longer as compared to the mid-length (Alternative B1/B2) alignments. Alternative C, which involves a shorter alignment and the use of cut-and-cover construction techniques, would have the greatest construction impacts compared to the mid-length alignments as it would result in additional impacts on air quality and noise because of the construction method. During operation, the project would provide a range of project benefits for the local community, and adverse effects are expected to be minimal. In operation, the longer alternatives would offer greater environmental benefits as a result of the extended undergrounding of the existing Caltrain alignment compared to the three shorter alternatives.

**Section 13.0** presents preliminary findings on the anticipated permits that will have to be acquired for the selected PAX alternative. **Section 14.0** provides recommendations for further technical studies, including recommended priorities in the following areas:

- DTX interface coordination and PAX project configuration;
- Engineering studies to refine/mitigate specific risks for the twin bore and single bore configurations;
- Infrastructure location and analysis;
- Conceptual engineering for 22nd Street Station and/or its replacement location; and
- Caltrain and CHSRA coordination.

In order to advance the PAX study most efficiently, these technical studies should be completed as part of a bridging phase prior to generation of the environmental documents. There are several items for which potential impacts should be better understood prior to configuration advancement. Collaboration with infrastructure stakeholders must also be advanced; for example, rail operations improvements resulting from the PAX project implementation and temporary operations required to accomplish PAX construction must satisfy Caltrain's needs. Finally, stations are integral to the full picture of what a PAX project could mean for San Francisco and should therefore be studied along with rail alignments in the next phase.

## 1.0 Project Purpose and Goals

### 1.1 Introduction

In 2014, the City and County of San Francisco (CCSF) initiated a multi-agency analysis of potential land use and transportation issues associated with several major infrastructure projects planned for the downtown area and the southeast portion of San Francisco. This analysis was presented in the Rail Alignment and Benefits (RAB) Study (CCSF, 2018a). More details of the RAB study are provided in Section 1.3. The RAB Study considered options for addressing the construction and operation of these major projects and evaluated how to best address existing connectivity and congestion challenges in the area while accommodating the rapid population growth that has occurred in the region over the past two decades and that is projected to continue in the future.

The RAB study evaluated the City of San Francisco's plan to connect the Peninsula Caltrain rail corridor (Caltrain) to the Salesforce Transit Center (located between Natoma and Minna Streets and Beale and Second Streets) via the construction of the Downtown Rail Extension (DTX) (Figure 1-1). This connection will facilitate future access by high-speed rail trains to San Francisco and support an increased number of Caltrain trains serving the Peninsula.

The RAB study confirmed the DTX alignment, which is environmentally cleared by the CEQA process and under design as of this writing, as the preferred alternative. The RAB study proposed an extension of underground rail service from the southern limit of DTX, under Pennsylvania Avenue, to reconnect with existing tracks near Cesar Chavez Street. The scope of the pre-environmental phase PAX Study is to evaluate tunnel alternatives and develop a Project Initiation Report for underground rail extension south of the current DTX project limits.

The proposed DTX project alignment transitions from a tunnel under Townsend Street to daylight at-grade adjacent to 7th Street just north of Mission Bay Drive. The DTX project includes a stub tunnel that is intended to tie into the future PAX tunnel and provide a construction interface between the two projects.

## 1.2 Project Description



**Figure 1-1. PAX Index Map Showing Corridor, Relationship with DTX, and Stations**

The PAX corridor is located in the City of San Francisco (the City) between the Mission Bay and Potrero Hill neighborhoods (Figure 1-1). The corridor is aligned approximately north to south, just west of Interstate Highway 280 (I-280) beginning at the intersection of 7th and Townsend Streets in the north and extending to the intersection of Cesar Chavez Street and Pennsylvania Avenue in the south. Historically, this was an industrial area with limited residential and community use. In recent decades, the South of Market Area (SOMA) has experienced significant changes. Increased residential and office development and the expansion of several major Bay Area regional transportation infrastructure networks have transformed the area.

The PAX corridor is adjacent to the I-280 freeway, which connects San Francisco to the South Bay. Caltrain surface rail, which connects San Francisco to the South Bay and beyond, extends along the corridor in a north-south direction terminating at the 4th/King (San Francisco) Station. I-280 runs on a viaduct above Caltrain throughout the corridor (from 25th Street to the 4th/King area), creating a physical and visual barrier that adversely impacts neighborhood connectivity. The Caltrain at-grade alignment through the corridor results in numerous bisections of local streets and requires two at-grade rail crossings located at the Mission Bay Drive and at 16th Street.

The PAX project will underground the existing at-grade Caltrain alignment at Mission Bay Drive and 16th Street, which will improve street connections between the Mission Bay District and SOMA/Potrero Hill. The PAX Project Initiation Report provides detailed technical evaluation of alternatives identified in the Alternatives Analysis Report (provided in Appendix A). This Project Initiation Report will serve as the basis for future Environmental Impact Studies for the project.

The overall objective of this study is to identify and evaluate feasible rail tunnel alignments that can be carried forward to the next stage. Future phases of planning and development for PAX will include environmental review and preliminary engineering. It is anticipated that a single, preferred rail alignment that could be designed and constructed would result from the CEQA/NEPA process.

### 1.3 Project History

Previous study has examined concepts for extending rail operations underground through the PAX study area:

- City and County of San Francisco Planning Department Rail Alignment and Benefits Study. Published September 2018 (CCSF, 2018b).

The 2018 Rail Alignment and Benefits (RAB) Study Final Technical and Executive Summary reports (CCSF, 2018b and 2018c) prepared by CH2M Hill for the San Francisco Planning Department summarized the evaluation process and alternatives for addressing the major transportation and land use issues resulting from electrification of Caltrain, the arrival of High-Speed Rail, and the DTX project. The technical report provides details of the relative advantages and disadvantages for the various alternatives as well as supporting documentation.

The RAB Study Final Technical and Executive Summary reports identified and recommended the Pennsylvania Avenue alignment as the preliminary preferred alignment for extending underground rail south from the environmentally cleared DTX project. The recommended alternative from the RAB Study was a 1.6-mile-long twin tunnel (split, or two tunnels with one track each) alignment from the DTX interface at the 4th and King railyard, down 7th Street and Pennsylvania Avenue, and connecting to the existing at-grade Caltrain tracks near Cesar Chavez. The PAX Study developed and evaluated multiple alternatives consistent with the broad definition of the preferred alternative from the RAB Study.

### 1.4 Existing Rail System Within Project Area

The existing commuter at-grade rail alignment along 7th Street includes two at-grade crossings at Mission Bay Drive and 16th Street. These are the only two major heavy rail grade crossings in use in San Francisco. In 2020 Caltrain operated five trains per hour in each direction at these grade crossings, and that number is expected to increase to 12 trains per hour (8 Caltrain and 4 HSR) in each direction by 2035.

The DTX project received its federal environmental Record of Decision in 2019, and engineering to develop the DTX is ongoing. The DTX alignment will transition trains from at-grade in the Caltrain ROW (adjacent to 7th Street) to a new below-grade station in the Caltrain ROW (adjacent to Townsend Street) between 4th and 5th Streets. The DTX project will also provide a stub tunnel that will accommodate the future PAX tunnel extension south along 7th Street, which is the subject of this report.

Within the PAX study area limits, the only currently existing commuter rail station is the 22nd Street Station, located at the corner of 22nd Street and Pennsylvania Avenue. The next station to the north is the San Francisco Station, currently located on the northwest corner of 4th and King Streets. The next station to the south is Bayshore, which is located primarily in the City of Brisbane on the west side of Tunnel Avenue north of its intersection with Beatty Avenue.

The Southeast Rail Station Study, undertaken by the San Francisco Planning Department, is currently evaluating future station locations within and adjacent to the PAX corridor to provide improved functionality and accessibility. The results of that study have not been finalized, and specific station

locations are not addressed in this report with the exception of discussion regarding options available to continue operation of the 22nd Street Station with the various alternative alignments. The long tunnel alignment alternatives completely bypass the existing 22nd Street Station and would result in its decommissioning. Short- and mid-length PAX alignment alternatives offer the ability to make continued use of the 22nd Street Station.

## 1.5 Project Goals

The primary purpose of the PAX project is to grade-separate the Caltrain rail alignment from surface streets within San Francisco. This purpose is driven by four primary goals.

- **Increase Connectivity between Mission Bay, Potrero Hill, and Design District/SOMA Neighborhoods:** The PAX project would reduce existing restrictions on local trips of all modes in the project corridor and would remove the physical and visual barrier of the at-grade Caltrain tracks that currently separates these neighborhoods. The delay experienced by bus transit passengers, pedestrians, bicyclists, and motorists at the at-grade crossing would increase without the project as the number of trains in the peak hour increases in the future; therefore, the gate closing occurrences would increase from ten trains/times per hour in pre-pandemic peak hours to 24 trains/hour in both directions in the peak hours in 2035. By alleviating vehicle congestion (especially on 16th Street), the PAX project would support and improve transit connections, and encourage pedestrian and bike trips.
- **Improve Safety of Pedestrian, Bicycle, and Vehicular Traffic on Surface Streets:** Growth along the project corridor and surrounding neighborhoods has resulted in greater demand for all modes of transportation in the area. The elimination of the existing at-grade Caltrain alignment would reduce congestion and potential safety concerns associated with street-level rail crossings and would allow for separation of travel modes through the corridor.
- **Enable Improved Efficiency of Caltrain Operations and Service Planning:** The PAX project would allow Caltrain and future CHSRA trains to travel at greater speed and frequency than is currently possible. Increasing the volume of trains would accommodate future population growth in the project corridor and the greater Bay Area and support the regional goal of decreasing VMT through increasing transit use (CCSF, 2018a).
- **Improve Quality of Life in Surrounding Neighborhoods:** Implementation of the PAX project would substantially reduce existing congestion, air quality, and noise effects associated with existing Caltrain and future rail traffic expansion. It would also improve the suitability of numerous city blocks that currently face the rail alignment for potential housing, retail, office, and other community uses.

## 1.6 Stakeholder Participation

Multiple meetings were held with stakeholders that make up the Technical Advisory Group (TAG). Organization members included the following entities:

- San Francisco County Transportation Authority (SFCTA)
- Caltrain



- California High-Speed Rail
- ProLogis (Railyards Development Project)
- Transbay Joint Powers Authority (TJPA), representing the Downtown Rail Extension (DTX) Project, and their Program Management and Program Controls Consultant AECOM/Mott MacDonald
- Caltrans
- San Francisco Public Utilities Commission
- San Francisco Planning Department, which is conducting a Stations Study along and near the PAX alignment

The purposes of the meetings were to: (1) keep stakeholders abreast of developments in the analysis of alternatives; (2) ensure the PAX team was aware of developments with advancement of interfacing projects like DTX, the stations study, and the railyards development; (3) facilitate coordination with Caltrain and CHSRA on design criteria and project needs; and (4) gain the input of stakeholders in the screening and alternatives evaluation process.

## **1.7 Report Authors**

McMillen Jacobs is the prime consultant for this PAX Study under contract to SFCTA and led the development of the Project Implementation Report and the associated studies. McMillen Jacobs was supported by the following subconsultants: PGH Wong (rail and systems), Environmental Science Associates (ESA; environmental studies), Slate Geotechnical Consultants (geotechnical), CHS Consulting (traffic), and Freyer & Laureta, Inc. (utilities).

## 2.0 Alternatives Definition

### 2.1 Description of Alternatives

The purpose of this section is to define each of the alternatives that were considered. The alternatives presented herein are A1/A2, B1/B2, and C. Alternatives D, E, and F are also briefly described in this section, and the reasons for their elimination during the screening process are explained in Section 3.0.

#### 2.1.1 Alternative A1: Long Alignment – Single Bore Tunnel

This alternative is a single tunnel bore with a 42-foot outside diameter (OD), excavated with a large-diameter tunnel boring machine (TBM) from north to south along 7th Street and Pennsylvania Avenue. A TBM would be launched from within a launch box constructed at the DTX/PAX interface (see Figure 2-1). A TBM launch from the south end of this alignment is also feasible. From the north launch area, the tunnel grade will slope down at a 2% grade to minimize potential for conflicts with existing and planned SFPUC utilities along 7th Street, including existing deep foundations for the Division Street Box Sewer. After passing beneath these utilities, the tunnel would then proceed flat to cross under 16th Street and then slope upwards, first at a 1% and then at a 2% grade to terminate adjacent to the existing Caltrain Tunnel 2 portal just north of Cesar Chavez. At the north end, the PAX alignment would connect to DTX below grade within a cut-and-cover structure constructed as part of DTX and connecting to PAX tracks installed as part of DTX. At the south end, the PAX alignment would connect to the existing Caltrain tracks near Cesar Chavez, just south of the new tunnel portal. The existing 22nd Street Station would be decommissioned.

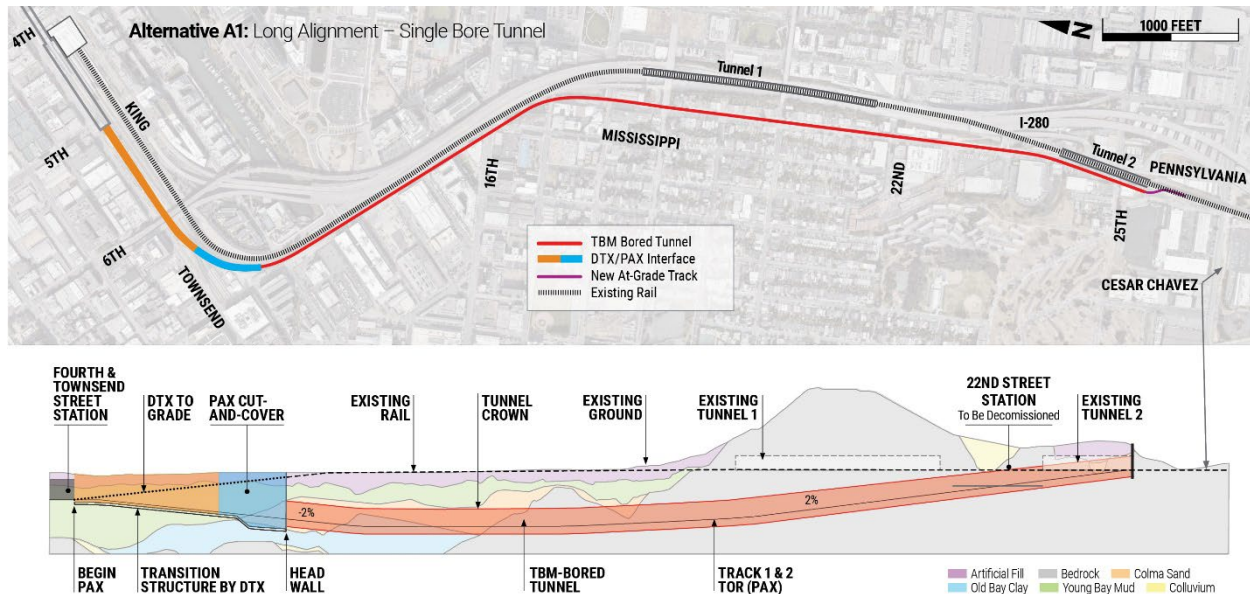
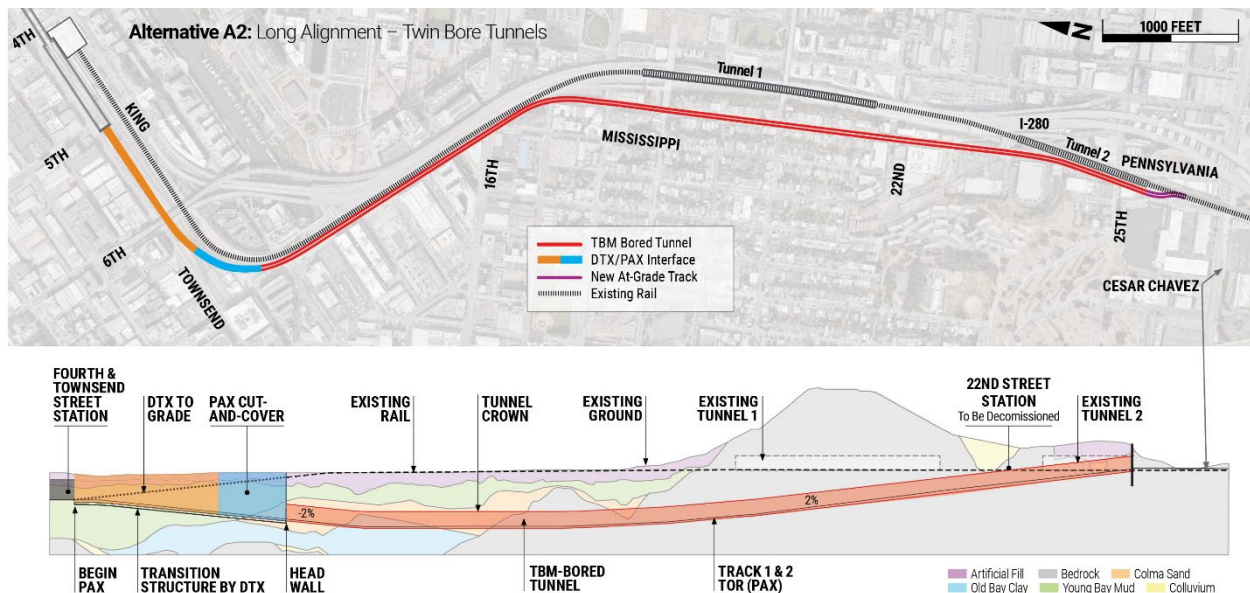

Figure 2-1. Long Alignment – Single Bore Tunnel. Rail and Existing Caltrain Tunnels noted. See also Appendix B.

#### 2.1.2 Alternative A2: Long Alignment – Twin Bore Tunnels

This alternative consists of twin 26-foot OD tunnels, excavated by TBM under 7th Street and Pennsylvania Avenue (see Figure 2-2). New portals will be constructed for the tunnels near the existing

Caltrain Tunnel 2 portals just north of Cesar Chavez. The TBMs can be launched from the north or south end. The north connecting point is the DTX/PAX interface at the transition structure constructed by DTX. At the south end the PAX alignment connects to the existing Caltrain tracks at the surface near Cesar Chavez Street and just south of the new tunnel portals. Of note is that the two tunnels run closer than one diameter apart because of the constricted tunnel corridor between existing I-280 deep foundation elements and the 7th Street right-of-way (ROW). Appendix B indicates the tunnels could be as close as 5 feet apart, though a center column of 13 feet may eliminate the need for pre-excitation ground treatment, as discussed in Section 7.2.2. The existing 22nd Street Station would be decommissioned.



**Figure 2-2. Long Alignment – Twin Bore Tunnels. Rail and Existing Caltrain Tunnels noted. See also Appendix B.**

### 2.1.3 Alternative B1: Mid-Length Alignment – Single Bore + SEM Tunnel

This alternative is a single tunnel bore (42-foot OD), excavated with a large-diameter TBM from north to south along 7th Street and Pennsylvania Avenue, as shown in Figure 2-3. TBM excavation would terminate between 19th and 20th Streets. TBM drives from south to north are not feasible for this alternative. A 22-foot-wide, horseshoe-shaped spur tunnel would extend to the southeast from the point of TBM termination to connect into the existing Caltrain Tunnel 1 just north of the existing southern portal and south of 20th Street. This tunnel would contain the northbound (easterly) track. The southbound (westerly) tunnel would also be 22 feet wide and would extend from the TBM termination point to a new portal adjacent to the existing south portal of Caltrain Tunnel No. 1. Both spur tunnels would be mined by SEM. Refinements to the limits of these excavation types can be examined during the subsequent project phases.

This alternative would allow continued use of the 22nd Street Station, with some modifications. (Note that station use could likely also remain unchanged with a different tie-in configuration similar to the connection used in Alternative C.) The city street bridge abutment at 22nd Street will likely require partial, but significant, demolition and reconstruction. A new retaining wall would be required along the west side of the station to allow new rail to be constructed at grade for the southbound track. The reason

for proposing new southbound rail as opposed to tying the new southbound track into the existing southbound track north of the station is to avoid demolition and reconstruction of an existing I-280 support column that interferes with a track alignment that ties directly into the existing southbound rail between the new portal and the 22nd Street Station. For this option, the 22nd Street Station would be converted to a center platform arrangement, which would require platform modifications. The southbound tracks continue southward from the 22nd Street Station via a rehabilitated abandoned Caltrain Tunnel 2, while the northbound line would remain in active Caltrain Tunnel 2. The tie-in to the existing southbound tracks would occur near Cesar Chavez Street just south of the existing portals.

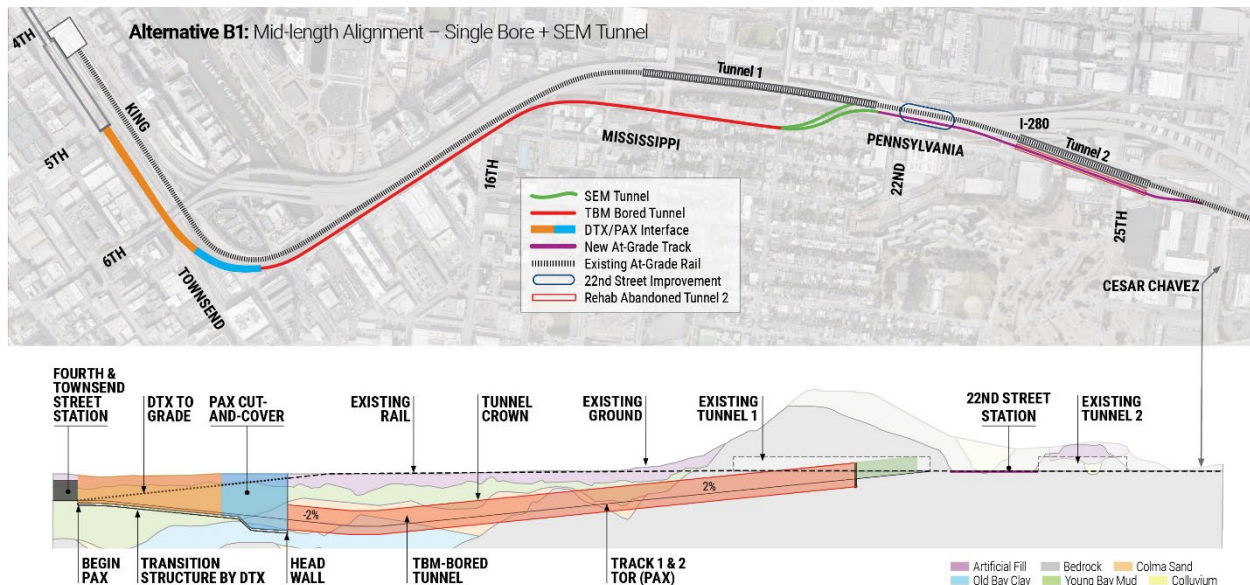

**Figure 2-3. Mid-Length Alignment – Single Bore + SEM Tunnel. Rail and Existing Caltrain Tunnels Noted. See also Appendix B.**

### 2.1.4 Alternative B2: Mid-Length Alignment – Twin Bore + SEM Tunnels

This alternative consists of twin 26-foot OD tunnels, excavated by TBM from north to south along under 7th Street and Pennsylvania Avenue as shown in Figure 2-4. TBM drives from south to north are not feasible for this alternative. The TBM for the northbound (easterly) tunnel drive curves southeast under private property to terminate at or near a new break-in to existing Caltrain Tunnel No. 1. The TBM drive for the southbound (westerly) tunnel also curves southeast under private property to a termination point at or near a new portal adjacent to the existing southern portal of Caltrain Tunnel 1, just north of the 22nd Street Station. Some portion of one or both new tunnels will likely require some amount of SEM mining from the TBM termination point to the break-in points at the new portal or into Tunnel No. 1. Refinements to the limits of these excavation types can be examined during subsequent project phases.

This alternative is similar to Alternative B1 in that it would allow continued use of the 22nd Street Station with some modifications. (Note that station use could also remain unchanged with a tie-in configuration similar to Alternative C.) The city street bridge abutment at 22nd Street may require modification. A new retaining wall would be built along the west side of the station to allow new rail to be constructed at grade for the southbound track. The 22nd Street Station would be converted to a center platform arrangement, which would require platform modifications. The southbound tracks continue southward from the 22nd Street Station via a rehabilitated abandoned Caltrain Tunnel 2, while the northbound line remains in

Active Caltrain Tunnel 2. Tie-in to the existing southbound tracks occurs near Cesar Chavez, just south of the existing portals.

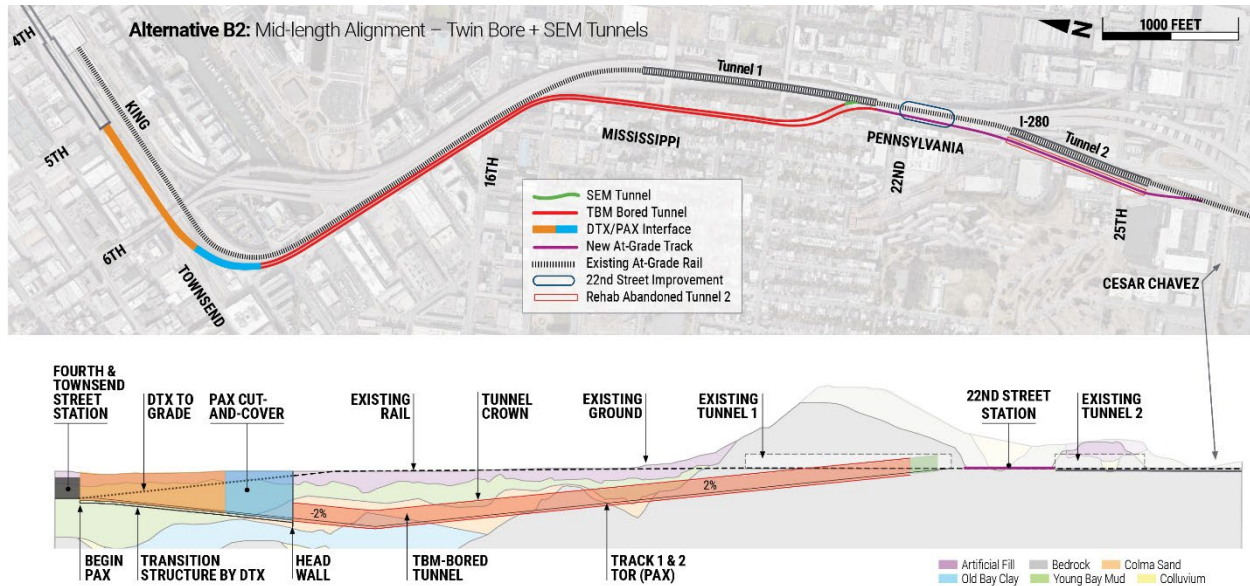

**Figure 2-4. Mid-Length Alignment – Twin Bore + SEM Tunnels. Rail and Existing Caltrain Tunnels Noted. See Appendix B.**

### 2.1.5 Alternative C: Short Alignment – Split Tunnels

This alternative involves two different types of excavations for the northbound and southbound tracks. The 26-foot-OD southbound (westerly) tunnel would be excavated by a single TBM from north to south along 7th Street and Pennsylvania Avenue, curving under private property and terminating at a new portal near the existing Caltrain Tunnel 1 south portal (see Figure 2-5). TBM mining from south to north is not feasible for this alternative. The southbound track would tie-in with existing southbound track just north of the 22nd Street Station. This tie-in may require modification of I-280 viaduct support that interferes with the rail alignment that is necessary to avoid modifications to the 22nd Street Station. The existing 22nd Street Station can be used in its current configuration without modification.

For the northbound tracks, a 20-foot-wide rectangular northbound (easterly) cut-and-cover tunnel would be excavated and supported within the Caltrain ROW from the DTX/ PAX interface, down under the existing Caltrans viaduct, to a location between Mariposa Street and 18th Street, where the PAX elevation meets the existing Caltrain track elevation at the northern portal of Caltrain Tunnel 1. Between approximately 16th Street/Mississippi Street and Mariposa Street, the PAX northbound track alignment would be in a trench with no cover as the vertical grade rises southward to meet the existing at-grade track. The northbound tunnel crossings of 16th Street and Mission Bay Drive will be constructed using cut-and-cover methods and will require partial closures of these intersections during construction.

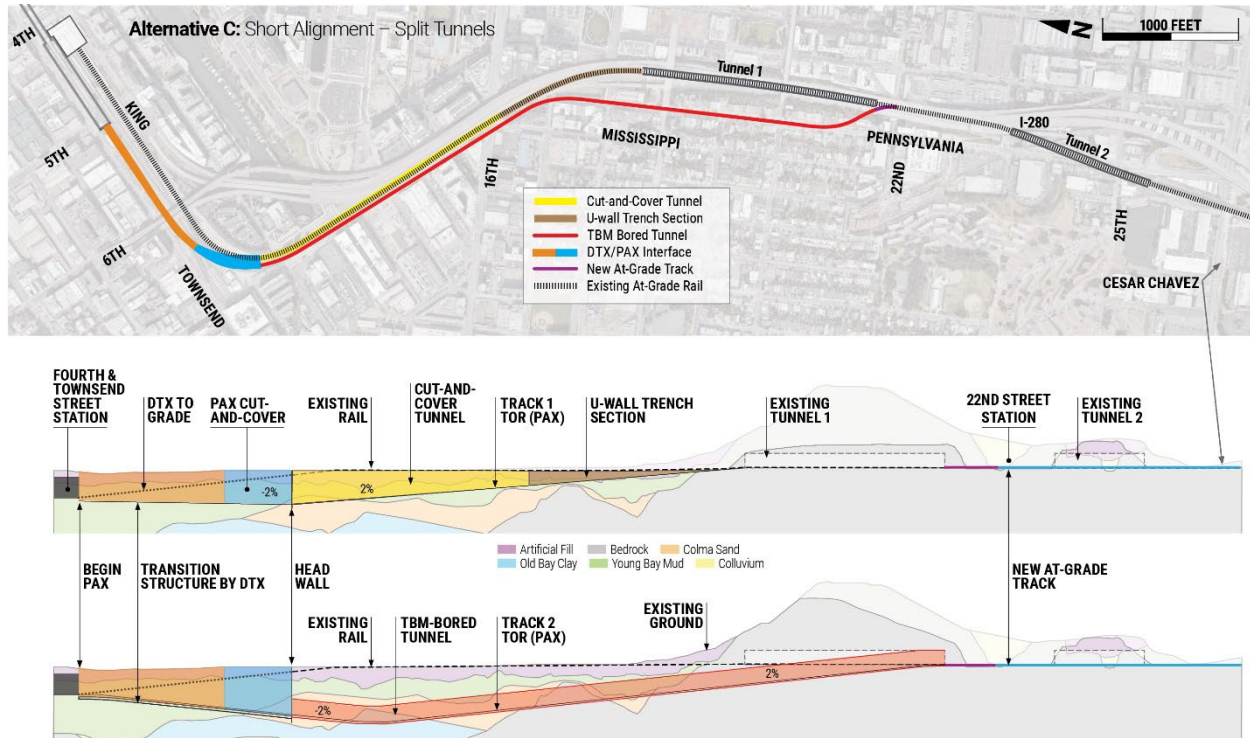

Figure 2-5. Short Alignment – Split Tunnels. Rail and Existing Caltrain Tunnels Noted. See also Appendix B.

### 2.1.6 Alternatives D, E, and F

Alternatives D, E, and F were removed from further consideration in the screening process as described in Section 3.0. These alternatives are briefly described below.

- Alternative D:** This alternative is a single tunnel bore (42-foot OD) excavated with a large-diameter TBM from north to south along 7th Street and Pennsylvania Avenue, launched from within the DTX transition structure at the DTX/PAX interface. The TBM would excavate to approximately 20th Street. At this point, a 22-foot spur tunnel would extend to the southeast toward the southern portal of the existing Caltrain Tunnel 1. The spur tunnel would carry the northbound (easterly) track and would be mined by SEM. This alternative would allow continued use of only the northbound tracks the 22nd Street Station. The TBM continues for the southbound (westerly) track to tie into the existing Caltrain track at 23rd Street, making use of the abandoned Caltrain Tunnel 2 for the final southern-most segment. Lowering of the existing Caltrain tunnel invert is required for the length of Tunnel 2. This alternative was abandoned because it was functionally similar to Alternative A but was more costly and reduced train operating speeds.
- Alternative E:** This alternative is similar to Alternative C except that the southbound tunnel and track connection is between 22nd and 23rd Streets, rather than north of 22nd Street. This alternative would allow continued use of only the northbound platform of the 22nd Street Station. Lowering of the abandoned Caltrain Tunnel 2 is also required. This alternative was abandoned because it was functionally similar to Alternative A but was more costly and reduced train operating speeds.

- **Alternative F:** This alternative is a single bore tunnel (42-foot OD) excavated with a large diameter TBM from north to south on 7th Street and Pennsylvania Avenue. The TBM excavation termination point is between 22nd and 23rd Streets. From this point southward, a cut-and-cover tunnel would be constructed to daylight south of the existing 22nd Street Station and tie into the existing Caltrain tracks before the Caltrain Tunnel 2 and just south of the existing 22nd Street Station. This alternative was abandoned because of low cover requiring cut-and-cover construction on Pennsylvania Avenue.

## 3.0 Alternatives Evaluation

### 3.1 Alignment Validation Process

During January and February of 2021, the project team participated in a validation process together with the SFCTA and an independent consultant, Brierley Associates, under separate contract to SFCTA. The process reviewed major constraints and risks to the project posed by the selection of six different project alternatives (A1/A2, B1, C, D, E, and F). Following the validation process, three of the original alignment alternatives were eliminated from further study: Alternatives D, E, and F. One variation of alignment Alternative B1, Alternative B2, was added, for a total of three alternatives, two of which can be accomplished in two different configurations. The three screened alignment alternatives that were dropped are presented below, along with reasons why they were not selected for further study. The alignments carried forward for study were then scored using the evaluation framework matrix described herein.

### 3.2 Alignment Alternatives Screened Out

**Alternative D Alignment:** This alternative was eliminated from further consideration because its disadvantages would not be offset adequately by achievement of project goals. Disadvantages include the introduction of multiple tunneling methods and risks associated with the required lowering of the existing abandoned Caltrain Tunnel 2. Although the single bore would allow for crossovers and cross passages to be constructed inside the running tunnel, this alternative carries an increased risk ground settlement between 16th and Mariposa Streets and between 22nd and 23rd Streets. In this portion of the alignment, track grade constraints and required connections to the existing system result in less than one tunnel diameter of ground cover above the tunnel crown. In addition, only one of the tracks could make use of the existing 22nd Street Station.

**Alternative E Alignment:** This alternative was eliminated from further consideration because it presents disadvantages that would not be offset by adequate achievement of project goals. Disadvantages include the introduction of multiple tunneling methods, and the required lowering of the existing abandoned Caltrain Tunnel 2, as well as potentially significant interruptions to Caltrain operations during construction work windows. The construction of this option would cause significant surface disruptions, including risky and costly construction of required cross passages and crossovers, and a potential requirement for a shoofly south of 16th Street. In addition, only one of the tracks could make use of the existing 22nd Street Station.

**Alternative F Alignment:** This alternative was eliminated from further consideration because it presents disadvantages that would not be offset by adequate achievement of project goals. The SFPUC's new Folsom Street Tunnel and existing Division Street Sewer potentially conflict with this alignment. Although the single bore would allow for crossovers and cross passages to be constructed inside the running tunnel, this alternative also requires cut-and-cover construction in Pennsylvania Avenue South of 22nd Street and presents possible impacts to the 23rd Street bridge. In addition, this option completely bypasses the existing 22nd Street Station. Finally, a tight radius S-curve needed to tie into Caltrain at the south end of the alignment will limit train speeds.



### 3.3 Evaluation Framework Matrix

The use of an evaluation framework matrix allows qualitative comparison of project alternatives by applying a defined set of evaluation criteria consistently to all alternatives and then weighting the criteria based on relative importance.

The evaluation framework enables differentiation between alternatives by:

- Identifying distinct assessment criteria against which alternatives can be evaluated. These criteria reflect factors that relate to the construction and operation of the project.
- Comparing each alternative against the criteria and giving each a numeric rating that indicates whether the alternative contributes to, detracts from, or is neutral with respect to each criterion.
- Weighing criteria categories and individual criteria to assign relative importance of one criterion over another and providing a means to balance groupings of criteria that have an unequal number of criteria within each category. This method assigns greater priority to those criteria that are considered most important and reduced priority to those that are of less importance.

Using this methodology to evaluate each alternative ensures that all alternatives are treated consistently and can be ranked on advantages or disadvantages in an equal manner. The percentages shown below are the initially identified values for weighting and may be modified during future evaluation exercises.

### 3.4 Overview of the PAX Evaluation Framework Matrix

To develop the evaluation framework matrix shown in Table 3-1, the PAX project team identified the key criteria that were considered important issues, including impacts associated with the construction and operation of the PAX project. In addition to project total cost and schedule duration, the team identified temporary impacts associated with construction, potential risks/impacts associated with third-party entities and actions, and the ultimate benefits afforded by each alternative with respect to the project objectives.

The concept of using an evaluation framework was first introduced to the PAX Technical Advisory Group (TAG) in mid-August 2020. An early version of the matrix was circulated to the TAG for input in late August. Over subsequent months the framework matrix was further refined based on discussions within the project team and input from TAG.

**Table 3-1. Evaluation Framework**

| Criteria Category | Criteria                     | Weight Within Category (%) | Category Weight (%) | Overall Individual Weights (%) |
|-------------------|------------------------------|----------------------------|---------------------|--------------------------------|
| Project Goals     | Improves Street Connectivity | 25                         | 25                  | 6.3                            |
|                   | Improves Quality of Life     | 25                         |                     | 6.3                            |
|                   | Improves Rail Operations     | 25                         |                     | 6.3                            |
|                   | Improves Surface Safety      | 25                         |                     | 6.3                            |

| Criteria Category  | Criteria                                | Weight Within Category (%) | Category Weight (%) | Overall Individual Weights (%) |
|--------------------|---|----------------------------|---------------------|--------------------------------|
| Project Interfaces | DTX Compatibility                       | 30                         | 20                  | 6.0                            |
|                    | Railyard Compatibility                  | 20                         |                     | 4.0                            |
|                    | 22nd Street Compatibility               | 30                         |                     | 6.0                            |
|                    | Infrastructure Compatibility            | 10                         |                     | 2.0                            |
|                    | ROW Needs                               | 10                         |                     | 2.0                            |
| Construction       | Constructability                        | 20                         | 15                  | 3.0                            |
|                    | Geologic Profile                        | 20                         |                     | 3.0                            |
|                    | Disruption to Rail Operations           | 40                         |                     | 6.0                            |
|                    | Access and Laydown Areas                | 20                         |                     | 3.0                            |
| Environmental      | Traffic and Transit                     | 20                         | 10                  | 2.0                            |
|                    | Air Quality                             | 10                         |                     | 1.0                            |
|                    | Noise and Vibrations: Construction      | 20                         |                     | 2.0                            |
|                    | Noise and Vibrations Operations         | 20                         |                     | 2.0                            |
|                    | Cultural Resources: Archaeology         | 10                         |                     | 1.0                            |
|                    | Cultural Resources: Historic Properties | 10                         |                     | 1.0                            |
|                    | Community Disruption                    | 10                         |                     | 1.0                            |
| Programming        | Cost                                    | 40                         | 30                  | 12.0                           |
|                    | Schedule                                | 30                         |                     | 9.0                            |
|                    | Risk                                    | 30                         |                     | 9.0                            |

### 3.5 Evaluation Methodology

The following methodology was used to determine the performance rating for each alignment alternative by criteria. Project Goals, Project Interfaces, Construction, and Environmental are category headings and are further broken down into subcategories. Cost, Schedule, and Risk are presented as subcategories under the heading Programming.

#### 3.5.1 Project Goals

The long-term benefits of each alternative were also assessed for a variety of criteria that represent the performance of each alternative with respect to the purpose, need, and objectives of the project. These include enhanced street connectivity, improved seismic performance, improved rail operations, and surface safety. Each of these is further described below.

### 3.5.1.1 Improves Street Connectivity

A key aspect of the purpose and need for this project,<sup>1</sup> street connectivity, assesses the amount of enhanced street connectivity for all travel modes (vehicle, bike, pedestrian) that would be created from each alternative, and is assessed by a qualitative assessment of post-project grade separated intersections within the study area that the Caltrain alignment would intersect as follows:

- 1 = Marginal increase in street connectivity.
- 2 = Moderate increase in street connectivity.
- 3 = Significant increase in street connectivity.

### 3.5.1.2 Improves Quality of Life

This criterion is a measurement of how each alternative improves quality of life in surrounding neighborhoods over and above existing conditions. It is primarily related to substantial reductions in existing congestion, air quality, and noise effects associated with existing Caltrain and future rail traffic expansion. It also relates to improvements in the suitability of numerous city blocks currently facing the rail alignment for potential use as housing, retail, offices, and other community uses.

- 1 = No improvements to quality of life along a percentage of the journey.
- 2 = Improvements made to quality of life.
- 3 = Significant improvements made to quality of life.

### 3.5.1.3 Improves Rail Operations

This criterion reflects each alternative's enhancement of Caltrain rail operations as measured by flexibility in operations, and enhancements in rail operations. The ability to install track crossovers is one potential differentiator for this criterion.

- 1 = Offers the least amount of flexibility and enhancements to rail operations.
- 2 = Offers some flexibility and enhancements in rail operations.
- 3 = Offers the most flexibility and enhancements in rail operations.

### 3.5.1.4 Improves Surface Safety

Although similar to street connectivity, this criterion assesses the overall safety benefits of undergrounding the Caltrain operations in the study area, which will result in a decrease of risk of conflicts with automobiles, bicycles, and pedestrians along the entire rail corridor (rather than only at intersections), and therefore is quantified in terms of linear feet of Caltrain grade separation through the study area.

- 1 = Marginal increase in automobile, pedestrian, and bicycle safety.

---

<sup>1</sup> See Appendix C for the “Pennsylvania Avenue Tunnel Extension Project Preliminary Draft: Purpose and Need.”

- 2 = Moderate increase in automobile, pedestrian, and bicycle safety.
- 3 = Significant increase in automobile, pedestrian, and bicycle safety.

### **3.5.2 Project Interfaces**

The alternatives were also assessed for their potential to affect or be affected by outside stakeholder actions and their potential to require negotiations with third parties, including right-of-way requirements/easements and compatibility with railyard design. These impacts are not limited to the construction phase of the project.

#### **3.5.2.1 Compatibility with DTX Design**

This criterion is a qualitative evaluation of the interface and coordination required between the PAX configuration and the DTX design.

- 1 = The coordination between PAX and DTX is complicated and costly, and there are anticipated to be significant impacts to station or staging, during PAX construction and final configuration.
- 2 = Moderate coordination and impacts to station or staging, during PAX construction.
- 3 = Minimal coordination and impacts to station or staging, during PAX construction.

#### **3.5.2.2 Compatibility with Railyard**

This criterion is a qualitative evaluation of the interface and coordination required between the PAX configuration and the operating railyard as well as a proposed subsurface railyard.

- 1 = The coordination between PAX the railyard is complicated and costly, and there are anticipated to be significant impacts to staging, and/or storage/maintenance during PAX construction and final configuration.
- 2 = Moderate coordination and impacts to staging and/or storage/maintenance during PAX construction.
- 3 = Minimal coordination and impacts to staging and/or storage/maintenance during PAX construction.

#### **3.5.2.3 Compatibility with 22nd Street Station**

This criterion is reflective of an alignment's ability to service the existing surface station at 22nd Street. For alignments that score low for this criterion, major modifications to station elevation and passenger movements would be required to retain a 22nd Street Station. Modifications to the surface station may be required for alignments which make use of the surface station.

- 1 = Neither track passes through existing station.
- 2 = Partial station use: One track only.
- 3 = Both tracks can service existing station.

### 3.5.2.4 Compatibility with Existing and Major Planned Infrastructure

This criterion is an assessment of known significant existing infrastructure (e.g., Caltrans foundations and Folsom Sewer) situated near or crossing the proposed alignment that conflicts with the proposed construction. These conflicts may cause limits to design or construction options, increased costs or longer schedule, unfavorable vertical or horizontal alignment to avoid the conflict, or the risk of damage to the adjacent infrastructure.

- 1 = Conflict with multiple large existing infrastructure components that can add significant complexity, cost, and risk to relocations or adjustments to alignment to resolve the conflicts.
- 2 = A moderate level of relocations are required, and existing large infrastructure facilities are largely avoided.
- 3 = Alternative with the least number of conflicts with existing infrastructure.

### 3.5.2.5 ROW Requirements and Easements

This criterion assesses the number of right-of-way takes (either partial or full) and temporary and permanent easements that would be required to construct and operate the alternative. For the purposes of this assessment, greater weight was given to those right-of-way needs from private owners rather than those needed from public or quasi-public entities. By way of example, alternatives that are confined to a public street ROW will score highest. Alternatives that include long sections that cross private property to tie into the existing Caltrain line will score lowest.

- 1 = A significant number of temporary and permanent easements and takes will be required.
- 2 = A moderate level of temporary and permanent easements and takes will be required.
- 3 = The alternative is largely in the public ROW with the least number of takes required.

## 3.5.3 Construction Impacts

A variety of criteria were developed to capture a range of potential considerations associated with construction impacts. These considerations are associated with the construction of each alignment alternative (vs. operations and maintenance).

### 3.5.3.1 Constructability

This criterion is a representation of the ease and efficiency with which each alternative can be constructed. Included in consideration are risk mitigations that will be required to facilitate project excavations and support installation.

- 1 = Significant mitigations and/or complex design and construction.
- 2 = Moderate mitigations and complexity of design and construction.
- 3 = Least risk mitigations required; simple/efficient design and construction.

### 3.5.3.2 Geologic Profile

This criterion captures the potential to encounter unanticipated or uncertain subsurface conditions that strongly influence the project construction approach and, ultimately, project success.

- 1 = High likelihood or high potential impact of detrimental subsurface conditions.
- 2 = Moderate likelihood or moderate potential impact of detrimental subsurface conditions.
- 3 = Mild likelihood or low potential impact of detrimental subsurface conditions.

### 3.5.3.3 Disruption to Rail Operations

This criterion addresses disruption to Caltrain operations during construction of the PAX alternative. This criterion assesses both service interruptions/outages and required modifications to operations by qualitatively comparing disruption including outages to Caltrain service and required single track service caused by the PAX construction.

- 1 = Significant, complicated, and lengthy interruptions to existing operations.
- 2 = Moderate level of disruption and not overly complicated with respect to operations coordination and construction implementation.
- 3 = Alternative that is the least disruptive with fewest interruptions to existing service.

### 3.5.3.4 Access and Laydown Areas

This criterion is an assessment of feasible access and laydown areas in proximity to support construction of the alternative. It captures the increased cost, schedule, emissions, traffic, and construction complexity for alternatives that require use of access/laydown staging areas at further distances from the proposed alignment.

- 1 = Remote: No potential construction staging areas were identified near the portal or entry point that can support construction of the alternative.
- 2 = Nearby: Potential staging areas are not in the immediate vicinity to the alternative but are reasonably close by the portal or entry point that can support construction of the alternative.
- 3 = Adjacent: A potential staging area is immediately adjacent to a portal or entry point that can support construction of the alternative.

## 3.5.4 Environmental Impacts

The potential to introduce environmental impacts, either during the construction phase or the operation phase, was evaluated for each alignment.

### 3.5.4.1 Traffic and Transit

The traffic and transit impacts of construction activities for each alternative are assessed. This criterion will examine impacts to local vehicle, pedestrian, and transit traffic from construction activities. It will

include such factors as the likelihood that construction sites will require major detours that will disrupt traffic or increase localized congestion, close pedestrian walkways, or reroute existing transit service.

- 1 = Construction activities will have a significant and lengthy impact on local traffic and/or transit.
- 2 = Construction activities will have a moderate impact on local traffic and/or transit.
- 3 = This is the alternative that is anticipated to have the least impact to traffic and transit.

#### **3.5.4.2 Air Quality**

This criterion is a qualitative assessment of construction impacts associated with air quality (e.g., dust), to nearby receptors. It is driven by factors such as the duration of construction, type of construction (e.g., open cut versus subsurface excavation), and proximity of construction and staging areas to sensitive receptors such as residences.

- 1 = Generally the most disruptive alternatives, with the greatest impact on sensitive receptors.
- 2 = Alternatives that result in a moderate amount of community disruption with shorter duration of impacts or proximity to less sensitive land uses.
- 3 = Generally the least or commensurate with the least disruptive of considered alternatives; construction sites are located in industrial or nonresidential areas.

#### **3.5.4.3 Noise and Vibration: Construction**

This criterion is a qualitative assessment of construction impacts associated with noise and vibration with respect to nearby receptors. It is driven by factors such as the duration of construction, type of construction (e.g., pile driving), and proximity of construction and staging areas to sensitive receptors such as residences.

- 1 = Generally the most disruptive alternatives, with the greatest impact on sensitive receptors.
- 2 = Alternatives that result in a moderate amount of community disruption with shorter duration of impacts or proximity to less sensitive land uses.
- 3 = Generally the least or commensurate with the least disruptive of considered alternatives; construction sites are located in industrial or nonresidential areas.

#### **3.5.4.4 Noise Vibration: Operations**

This criterion is a qualitative assessment of permanent impacts associated with noise and vibration to nearby receptors. It is driven by factors such as the depth of installed tunnels and proximity of tunnels to sensitive receptors such as residences.

- 1 = Generally the most disruptive alternatives, with the greatest impact on sensitive receptors.
- 2 = Alternatives that result in a moderate amount of vibration impacts with shorter duration of impacts or proximity to less sensitive land uses.

- 3 = Generally the least or commensurate with the least disruptive of considered alternatives; tunnel locations would be located in industrial or nonresidential areas.

### **3.5.4.5 Cultural Resources: Archaeology**

This criterion is a qualitative assessment used to assess potential significant impacts on archaeological resources such as adverse effects or significant impacts on archaeological resources that qualify for listing on the California Register of Historical Resources (California Register) or the National Register of Historic Places (National Register), or soils and landforms that may contain archaeological resources potentially eligible for either register. It is driven by factors such as sensitivity of landform for buried archaeological resources, and the potential to affect during construction archaeological resources potentially eligible for either the California Register or the National Register.

- 1 = Generally the most or commensurate with the greatest anticipated effects on eligible or potentially eligible archaeological resources and significant disturbance of soils sensitive for archaeological resources
- 2 = Alternatives that result in a moderate amount of potential effects to archaeological resources and moderate disturbance of soils sensitive for archaeological resources within the alignment corridor
- 3 = Generally the alternative with the least or commensurate with the least disruptive of soils sensitive for archaeological resources within the alignment corridor.

### **3.5.4.6 Cultural Resources: Historic Properties**

This criterion is a qualitative assessment used to assess potential adverse effects or significant impacts on historic architectural resources such as adverse impacts on historic architectural resources that qualify for listing on the California Register and/or the National Register. It is driven by factors such as the number of historic architectural resources eligible for either the California Register or the National Register potentially effected during construction and the anticipated level of effect for each resource.

- 1 = Generally the most or commensurate with the greatest anticipated effects on one or more historic architectural resource and the most disruptive of considered alternatives.
- 2 = Alternatives that result in a moderate amount of potential effects to known historic architectural resources within the alignment corridor.
- 3 = Generally the alternative with the least number of potential effects to known historic architectural resources within the alignment corridor.

### **3.5.4.7 Community Disruption**

This criterion is a qualitative assessment that combines a variety of impacts to community cohesion that may occur during construction, including impacts to pedestrian and bicycle access necessitated by direction travel, impacts to access and use of community features (e.g., Tunnel Top Park), and aesthetic impacts of construction (amount of visible construction fencing).

- 1 = Most or commensurate with the most disruptive of considered alternatives.



- 2 = Alternatives that result in a moderate amount of community disruption when compared to other alternatives considered.
- 3 = Least or commensurate with the least disruptive of considered alternatives.

### **3.5.5 Programming**

Anticipated cost, schedule, and risks were quantified and analyzed for the purpose of evaluating each alignment alternative.

#### **3.5.5.1 Cost**

The evaluation of cost is intended to allow the consideration of the total cost of each alternative in terms of design, management, and construction. All options evaluated in the Alternatives Analysis phase have a Class V cost estimate prepared. This allows comparison of estimated cost between the alternatives. Alternatives that are estimated to cost within 10% of each other were given the same score.

- 1 = Highest cost alternative.
- 2 = Middle cost alternative.
- 3 = Lowest cost alternative.

#### **3.5.5.2 Construction Schedule**

The time taken to construct each alternative is directly related to several factors including anticipated construction means and methods and estimated productivity. To the extent they are known at the time of the evaluation, schedule durations consider anticipated sequencing or impacts from external factors such as major utility relocations, tie-ins to existing Caltrain service, and special construction procedures that will likely be required to mitigate public impacts. Project schedule is evaluated in terms of estimated years of variation from the alternative with the shortest construction schedule.

- 1 = Three or more years longer than the schedule for the alternative with the shortest schedule.
- 2 = One to two years longer than the schedule for the alternative with the shortest schedule.
- 3 = Alternative with the shortest construction schedule.

#### **3.5.5.3 Risk**

A risk register has been developed to capture key potential hazards and risks associated with the design and construction of the project and to discuss potential impacts of those risks if mitigations are not implemented.

- 1 = Unlikely to meet project objectives without significant additional risk to the SFCTA or the construction contractor.
- 2 = Likely to meet project objectives with the SFCTA and construction contractor accepting some risk; requires implementation of risk mitigation measures.

- 3 = Likely to meet or exceed project objectives with lowest reasonable risk to SFCTA or construction contractor.

### 3.6 Analysis Results

The scores for the alternatives being carried forward for further study can be found in Table 3-2.

**Table 3-2. Evaluation Framework with Scoring**

| Criteria Category         | Criteria                                | Alternatives                            |  |  |  |                                    |
|---------------------------|---|---|--|--|--|------------------------------------|
|                           |   | A1: Long Alignment – Single Bore Tunnel | A2: Long Alignment – Twin Bore Tunnels | B1: Mid-Length Alignment – Single Bore + SEM Tunnels | B2: Mid-Length Alignment – Twin Bore + SEM Tunnels | C: Short Alignment – Split Tunnels |
| <b>Project Goals</b>      | Improves Street Connectivity            | 3                                       | 3                                      | 2  | 2  | 1                                  |
|                           | Improves Quality of Life                | 3                                       | 3                                      | 2  | 2  | 2                                  |
|                           | Improves Rail Operations                | 3                                       | 2.5                                    | 2  | 1.5  | 2                                  |
|                           | Improves Surface Safety                 | 3                                       | 3                                      | 2.5  | 2.5  | 2.5                                |
|                           | TOTAL                                   | 12                                      | 11.5                                   | 8.5  | 8  | 7.5                                |
| <b>Project Interfaces</b> | DTX Compatibility                       | 3                                       | 3                                      | 3  | 3  | 2                                  |
|                           | Railyard Compatibility                  | 2                                       | 2                                      | 2  | 2  | 1                                  |
|                           | 22nd Street Compatibility               | 1                                       | 1                                      | 3  | 3  | 3                                  |
|                           | Infrastructure Compatibility            | 3                                       | 2                                      | 2  | 2  | 1                                  |
|                           | ROW Needs                               | 2                                       | 1                                      | 3  | 3  | 3                                  |
|                           | TOTAL                                   | 10                                      | 10                                     | 12   | 11.5   | 10                                 |
| <b>Construction</b>       | Constructability                        | 2                                       | 2                                      | 1  | 2  | 1                                  |
|                           | Geologic Profile                        | 2.5                                     | 3                                      | 2  | 2  | 1                                  |
|                           | Disruption to Rail Operations           | 3                                       | 3                                      | 2.5  | 2  | 1                                  |
|                           | Access and Laydown Areas                | 2.5                                     | 3                                      | 1.5  | 2  | 1                                  |
|                           | TOTAL                                   | 10                                      | 11                                     | 7  | 8  | 4                                  |
| <b>Environmental</b>      | Traffic and Transit                     | 2                                       | 1                                      | 2  | 1  | 2                                  |
|                           | Air Quality                             | 1                                       | 1.5                                    | 2  | 2.5  | 2.5                                |
|                           | Noise and Vibrations: Construction      | 1                                       | 1                                      | 2  | 2  | 1                                  |
|                           | Noise and Vibrations: Operational       | 3                                       | 3                                      | 2  | 2  | 1                                  |
|                           | Cultural Resources: Archaeology         | 2                                       | 1.5                                    | 2  | 2  | 1                                  |
|                           | Cultural Resources: Historic Properties | 2                                       | 2                                      | 1  | 1  | 1.5                                |
|                           | Community Disruption                    | 1.5                                     | 2                                      | 2.5  | 3  | 1                                  |
|                           | TOTAL                                   | 12.5                                    | 12                                     | 13.5   | 13.5   | 10                                 |

| Criteria Category     | Criteria | Alternatives                            |  |  |  |                                    |
|-----------------------|----------|---|--|--|--|------------------------------------|
|                       |          | A1: Long Alignment – Single Bore Tunnel | A2: Long Alignment – Twin Bore Tunnels | B1: Mid-Length Alignment – Single Bore + SEM Tunnels | B2: Mid-Length Alignment – Twin Bore + SEM Tunnels | C: Short Alignment – Split Tunnels |
| Programming           | Cost     | 3                                       | 2                                      | 3  | 3  | 3                                  |
|                       | Schedule | 2                                       | 2                                      | 2  | 2  | 3                                  |
|                       | Risk     | 2                                       | 2                                      | 2  | 2  | 1                                  |
|                       | TOTAL    | 7                                       | 7                                      | 7  | 7  | 7                                  |
| <b>Total Score</b>    |          | <b>50</b>                               | <b>49.5</b>                            | <b>48.5</b>  | <b>47.5</b>  | <b>39.5</b>                        |
| <b>Weighted Score</b> |          | <b>2.2</b>                              | <b>2.1</b>                             | <b>2.1</b>   | <b>2.1</b>   | <b>1.9</b>                         |

### 3.6.1 Alternative A1: Long Alignment – Single Bore Tunnel

This alternative scored highest in the evaluation process with an overall weighted score of 2.2. Primarily because of its long length underground, this alternative scored the highest for meeting project goals, including improving rail operations and improving street connectivity and surface safety. Quality of life is also expected to be most improved by the long and mid-length alternatives. The longer alternatives scored lower than the mid-length and short alternatives for the project interface criteria, in part because they bypass the existing 22nd Street Station. This alignment requires right-of-way takes at its south end, so it scored a 2 for that criterion. All A and B alignments are assumed at this point to be viable for DTX and Railyard compatibility and were given 3s and 2s for those criteria, respectively.

A minimal impact of short duration is expected for rail service phase-in at the southern tie-in for the long alternatives (A1 and A2), so these alternatives qualify as the highest for that criterion. Alternative A1 scored highest for constructability (tied with Alternatives A2 and B2) and second highest for access and laydown areas. This alternative came in second for the geologic profile criterion because it is expected to encounter soft soils and mixed-face conditions for more of the excavation than the twin bore.

A feature of the large-diameter and long alignment is a slightly lower score for environmental criteria during construction than for the shorter and twin bore alignments, due in large part to the greater volume of trucks needed to remove muck and deliver tunnel lining segments, which contributes to air and noise impacts. However, once construction is complete, operational noise and vibrations are expected to be lowest for this alternative and for Alternative A2. During a tunnel drive excavated from the south end of the alignment, the LOS in the morning peak at Pennsylvania Avenue / Cesar Chavez Street / NB I-280 off-ramp is expected to degrade from LOS E to LOS F. During a tunnel drive excavated from the north end of the alignment, the LOS in the afternoon peak at 7th Street / Brannan Street and 7th Street / 16th Street is expected to degrade from LOS D to LOS E. There is an area of low cover over the tunnel that requires further investigation and will likely require either ground treatment or underpinning of the I-280 pile foundations, and ground treatment will be required in a zone near TBM launch. However, minimal ground improvement will be required because this alternative allows for crossovers between the northbound and southbound tracks, and required emergency cross passages, to be installed inside the

tunnel structure, and this means lower anticipated traffic and transit impacts as compared to Alternative A2.

This alignment tied with all alignments other than A2 for the programming scores. The estimated project schedules and risk scores of Alternatives A1, A2, B1, and B2 are comparable. The estimated costs for Alternatives A1, B1, B2, and C are lower than the estimate for Alternative A2, and are all within 10% of each other, so they received the same score.

### **3.6.2 Alternative A2: Long Alignment – Twin Bore Tunnels**

This alternative tied with Alternatives B1 and B2 for second in the evaluation process with an overall weighted score of 2.1. Primarily because of its long length underground, this alternative scored quite high for meeting project goals, including improving rail operations (where it scored just below Alternative A1) and improving surface safety. Quality of life is also expected to be most improved the long and mid-length alternatives.

The longer alternatives (A1 and A2) scored lower than the mid-length alternatives and short alternative for the project interface criteria, in part because they bypass the existing 22nd Street Station. This alignment will have right-of-way impacts to private properties and scored the lowest for that criterion. This alignment has a greater potential for conflict with existing Caltrans footings for I-280, so it received a middle score for that criterion. All A and B alignments are assumed at this point to be viable for DTX and Railyard compatibility and were given 3s and 2s for those criteria, respectively.

A minimal impact of short duration is expected for rail service phase-in at the southern tie-in for the long alternatives (A1 and A2), so these alternatives qualify as the highest for disruption to rail operations. Alternatives A2 scored highest for constructability (tied with Alternatives A1 and B2) and highest for access and laydown areas. This alternative scored highest for the geologic profile criterion as well because it has been best optimized to pass through favorable ground conditions.

This alignment requires two adjacent tunnels to be excavated with significantly less separation than is typically desired, and the required emergency cross passages and crossovers must be excavated outside the tunnel structure. Significant lengths (1,000+ feet) of ground treatment installed from the ground surface are anticipated to be required, resulting in a low score for traffic and transit impacts for this alignment. Other environmental criteria that relate to muck volume during construction, including air and noise impacts as well as archaeology, were scored lower for this alignment than for the shorter alignments. However, once construction is complete, operational noise and vibrations are expected to be lowest for this alternative and for Alternative A1.

This alignment has a slightly lower programming score than the other alignments. The estimated project schedules and risk scores of Alternatives A1, A2, B1, and B2 are comparable. The cost for this alternative is the highest and is just over 10% higher than the cost for Alternative A1, resulting in a lower score.

### **3.6.3 Alternative B1: Mid-Length Alignment – Single Bore + SEM Tunnels**

This alternative tied with Alternatives A2 and B2 for second in the evaluation process with an overall weighted score of 2.1. Primarily because of its shorter length underground, this alternative garnered

intermediate scores for meeting project goals, including improving rail operations (where it scored just above Alternative B2) and improving surface safety. Quality of life is expected to be improved the most by the long and mid-length alternatives.

The mid-length alternatives and short alternative (B1, B2, and C) scored higher than the long alternatives for the project interface criteria, in part because they make use of the existing 22nd Street Station. Alignments B1, B2, and C have the fewest right-of-way impacts, so they scored the highest for that criterion. Alternatives B1 and B2 have a greater potential for conflicts with SFPUC's Division Street Sewer at the north end of the alignment because they are shallower to allow for mid-alignment tie-ins to existing tracks, so they received middle scores for infrastructure compatibility. All A and B alignments are assumed at this point to be viable for DTX and Railyard compatibility and were given 2s for those criteria, respectively.

The use of SEM construction of the southernmost sections of this alignment and Alignment B2 minimizes construction time on active and inactive Caltrain tracks, but there will be impacts, so these alternatives scored in the middle for disruption to rail operations. This alternative tied with Alternative C for the lowest score for constructability and second lowest for access and laydown areas. This alternative and Alternative B2 were given scores of 2 for the geologic profile criterion because they are expected to encounter soft soils and mixed-face conditions for more of the excavation than the longer, deeper alignments.

This alternative tied with Alternative B2 for the highest environmental criteria scores. When compared with A1 and A2, the shorter tunnel lengths of B1 and B2 are related to decreased air quality and noise impacts, as well as decreased likelihood of archaeological impacts. During tunnel excavation, the LOS in the afternoon peak at 7th Street / Brannan Street is expected to degrade from LOS D to LOS E. There is an area of low cover over the tunnel that requires further investigation and will likely require either ground treatment or underpinning of the I-280 pile foundations, and ground treatment will be required in a zone near TBM launch. However, minimal ground improvement will be required because this alternative allows for crossovers between the northbound and southbound tracks, and required emergency cross passages, to be installed inside the tunnel structure, and this means lower anticipated traffic and transit impacts as compared to Alternative B2.

This alignment tied with all alignments other than A2 for the programming scores. The estimated project schedules and risk scores of Alternatives A1, A2, B1, and B2 are comparable. The estimated costs for Alternatives A1, B1, B2, and C are lower than the estimate for Alternative A2, and are all within 10% of each other, so they received the same score.

### **3.6.4 Alternative B2: Mid-Length Alignment – Twin Bore + SEM Tunnels**

This alternative tied with Alternatives A2 and B1 for second in the evaluation process with an overall weighted score of 2.1. Primarily because of its shorter length underground, this alternative garnered the second lowest score for meeting project goals, including improving rail operations (where it scored just below Alternative B1) and improving surface safety. Quality of life is expected to be improved the most by the long and mid-length alternatives.

The mid-length and short alternatives (B1, B2, and C) scored higher than the long alternatives for the project interface criteria, in part because they make use of the existing 22nd Street Station. Alignments B1, B2, and C have the fewest right-of-way impacts, so they scored the highest for that criterion. Alternatives B1 and B2 have a greater potential for conflicts with SFPUC's Division Street Sewer at the north end of the alignment because they are shallower to allow for mid-alignment tie-ins to existing tracks, so they received middle scores for infrastructure compatibility. All A and B alignments are assumed at this point to be viable for DTX and Railyard compatibility and were given 3s and 2s for those criteria, respectively.

The use of SEM construction of the southernmost sections of this alignment and Alignment B1 minimizes construction time on active and inactive Caltrain tracks, but there will be impacts, so these alternatives scored in the middle for disruption to rail operations. This alternative scored the highest in constructability (tied with A1 and A2) but in the middle for access and laydown areas. This alternative and Alternative B1 were given scores of 2 for the geologic profile criterion because they are expected to encounter soft soils and mixed-face conditions for more of the excavation than the longer, deeper alignments.

This alternative tied with Alternative B1 for the highest environmental criteria scores. The shorter tunnel length as compared to Alternatives A1 and A2 is related to decreased air quality and noise impacts, as well as decreased likelihood of archaeological impacts. During tunnel excavation, the LOS in the afternoon peak at 7th Street / Brannan Street is expected to degrade from LOS D to LOS E. Traffic impacts are expected to be worse for this alternative because the two adjacent tunnels will be excavated with significantly less separation than is typically desired, and the required emergency cross passages and crossovers must be excavated outside the tunnel structure. This means that significant lengths (1,000+ feet) of ground treatment installed from the ground surface are anticipated to be required, resulting in a low score for traffic and transit impacts for this alignment.

This alignment tied with all alignments other than A2 for the programming scores. The estimated project schedules and risk scores of Alternatives A1, A2, B1, and B2 are comparable. The estimated costs for Alternatives A1, B1, B2, and C are lower than the estimate for Alternative A2, and are all within 10% of each other, so they received the same score.

### **3.6.5 Alternative C: Short Alignment – Split Tunnels**

This alternative scored the lowest in the evaluation process with an overall weighted score of 1.9. Alternative C moves the shortest length of track underground, and therefore earned middle and low scores for meeting project goals, including improving rail operations and improving surface safety (where it is in a three-way tie with Alternatives B1 and B2). Notably, this alternative received the lowest score for improving street connectivity, primarily because it keeps more trains operating on the surface and does not allow for other uses of the land. Quality of life is expected to be improved the least by this alternative.

Alternative C scored higher than the long alternatives (A1 and A2) and lower than the mid-length alternatives (B1 and B2) for the project interface criteria. This alignment does make use of the existing 22nd Street Station, and has few right-of-way impacts, so it scored high for those criteria. But it also carries with it numerous risks related to unanticipated conditions because of its tight alignment between Caltrans I-280 bridge piers, possible impacts to those bridge piers, and possible conflicts with SFPUC's

Folsom Tunnel and Division Street Sewer at the north end of the alignment because it is shallow to allow for mid-alignment tie-in to existing tracks. As a result of all this, it received the lowest score for infrastructure compatibility. Alternative C will be most disruptive in the railyard and was therefore given a score of 2 for compatibility with DTX and 1 for compatibility with the Railyard.

This alternative scored low across the board for construction criteria. Major disruption at the Caltrain tracks is required for this option, so it scored low for disruption to rail operations. It also scored low for constructability, in large part because of the risk of unanticipated conditions along the long cut-and-cover portion of the alignment, and for access and laydown areas, which are not well aligned with construction locations. Finally, Alternative C scored low for geologic profile, because it is expected to encounter the greatest proportion of soft soils of any of the alignment alternatives.

This alternative received the lowest environmental criteria scores, primarily because of the large portion of work to be performed at the surface. One post-construction feature of this alignment that is expected is vibration impacts related to train operations. Community disruption is expected to be highest with this alignment.

This alignment tied with all alignments other than A2 for overall programming score. The risk is expected to be highest for this alternative. The short and mid-length alignments are forced to be shallower by tie-in elevations at each end, and therefore pass through less favorable ground conditions. However, based on available information, this alignment is expected to take slightly less time than other alternatives, and therefore has a favorable project schedule. The estimated costs for Alternatives A1, B1, B2, and C are lower than the estimate for Alternative A2, and are all within 10% of each other, so they received the same score.

### **3.7 Alternatives Evaluation Summary**

The evaluation framework yielded a close range in overall scoring, from a low of 1.9 for Alternative C to a high of 2.2 for Alternative A1. The greatest disparity on scoring is for construction, which resulted in Alternatives A1 and A2 having scores of 10 to 11 versus 4 to 8 for B1, B2, and C. The scoring for the project goals criteria also resulted in a clear separation, with A1 and A2 having scores of 11.5 and 12, respectively, while B1, B2, and C ranged from 7.5 to 8.5. It must be noted that the scoring does not factor in the final selection of station location in a meaningful way, as a study of a PAX station is outside the scope of this study. It is anticipated that a decision on making use of the existing 22nd Street Station versus decommissioning it would push either the A1/A2 group (decommissioning) or the B1/B2/C group (make use of) to the favored alternative shortlist. Features that relate to a number of the criteria evaluated, including project goals and impacts, are summarized in Table 3-3. Alignment Alternative Features (from Alternatives Analysis Report)

**Table 3-3. Alignment Alternative Features (from Alternatives Analysis Report)**

| Alternative  | Screening Criteria                          |  |  |                                      |  |   |
|--|---|--|--|--------------------------------------|--|---|
|  | Grade Separation at 16th, Mission Bay Drive | Supports Future Train Operations (meets grade and radius requirements) | Minimizes Impacts on Adjacent Projects | Minimizes Impacts to Rail Operations | Maintains Minimum One Diameter (1D) of Ground Cover (for tunneled sections) <sup>1</sup> | Minimizes Length of Tunnel Excavation in Unstable Soils |
| A1: Long Alignment – Single Bore Tunnel  | X   | X  | X                                      | X                                    | X  | X   |
| A2: Long Alignment – Twin Bore Tunnels   | X   | X  | X                                      | X                                    | X  | X   |
| B1: Mid Alignment – Single Bore + SEM Tunnel   | X   | X  | X                                      |                                      |  |   |
| B2: Mid Alignment – Twin Bore + SEM Tunnels  | X   | X  | X                                      |                                      | X  |   |
| C: Short Alignment - Split Tunnels   | X   | X  |  |                                      | X  |   |
| <sup>1</sup> One diameter of ground cover maintained for most (85%) of tunnel length. Remainder of tunnel length (15%, or approximately 1,300 feet) maintains at least 0.75 x diameter (0.75xD). |   |  |  |                                      |  |   |



## 4.0 Rail Operations and Interfaces

The PAX corridor will be configured and designed to support operations of Caltrain commuter rail trains and future CHSR trains under blended operations. The operations, fire/life safety, and rail systems design for PAX will conform to both Caltrain and High-Speed Rail design criteria and requirements.

### 4.1 System Capacity

Caltrain and High-Speed rail are both intended to operate on the PAX corridor under blended operations.

**Planned Blended Operations:** Caltrain’s 2035 Business Model projects 2035 service of 8 Caltrain Trains and 4 HSR trains during peak hours in each direction. Off-peak projections call for 6 Caltrain and 3 HSR trains per hour in each direction.

**Operating Speeds:** Caltrain and High-Speed Rail are intended to operate at speeds of up to 110 mph where permitted and achievable by alignment constraints between San Francisco and San Jose. For the PAX corridor, the minimum horizontal curve radius is 650 feet, which corresponds to 30 mph operating speed. Horizontal curve radius in the northern railyard area will roughly match the planned DTX alignment and will have an operating speed of 30 mph. On average, all PAX alignment alternatives have similar horizontal curves and are expected to have similar reduced operating speeds through curves.

### 4.2 Caltrain Operations

Caltrain service will operate through the PAX corridor with planned station stops at the existing 22nd Street or a new mid-project station as well as at Fourth and Townsend Street and the Salesforce Transit Center. The following are detailed operation descriptions for the three main alternatives (see Section 5.1):

- **Alternative A1/A2 – Long Alignment:** A new interlocking near Cesar Chavez Street will be provided to redirect trains traveling in both directions from the current rail alignment to the west and into a new tunnel portal near 25th Street and Pennsylvania Avenue. Trains will remain in this new tunnel for the full length of the PAX project and will enter the Fourth and Townsend Street Station at the interface with the DTX project in area of 6th Street and Townsend Street.
- **Alternative B1/B2 – Mid-Length Alignment:** Southbound trains will tie into the existing blended rail system south of Tunnel 2 through an interlocking near Cesar Chavez Street. This will be necessary because the southbound alignment is routed through the currently abandoned section in Tunnel 2 that will be rehabilitated. Northbound trains will remain on the existing blended system tracks north through Tunnel 2 and will tie into the new PAX system through a new interlocking inside Tunnel 1 near the existing south portal. Caltrain will operate in a new tunnel for the remaining length of the PAX project and will enter the Fourth and Townsend Street Station at the interface with the DTX project in area of 6th Street and Townsend Street.

Caltrain trains will stop at a reconfigured, at-grade 22nd Street Station. A passing track could be provided for northbound trains to allow “skip-stop” service at 22nd Street Station, where express trains could use the existing northbound tracks through the 22nd Street Station to pass dwelling Caltrain trains since a new, third set of tracks could be provided through the 22nd Street Station area. The extent of passing tracks would be from the north portal of Tunnel 2 to the south portal

of Tunnel 1. For operational flexibility, crossovers could be provided beyond each end of the passing to allow southbound Caltrain express trains to also access the passing track through the 22nd Street Station by locally crossing over to the northbound tracks. On the north end, this crossover exists on Alternative B2 to meet fire/life safety criteria; on Alternative B1, an additional crossover could be added. On the south end, a crossover in the vicinity of Cesar Chavez Street near CP Army could be included.

- **Alternative C – Short Alignment:** Southbound tracks will tie into the existing blended rail system through a new interlocking between the south portal of Tunnel 1 and the 22nd Street Station. Southbound trains will continue in a new PAX tunnel for the remaining length of the PAX project and will enter the Fourth and Townsend Street Station at the interface with the DTX project in area of 6th Street and Townsend Street. The northbound tracks will tie into the existing blended system at the north portal of Tunnel 1 near Mariposa Street. The northbound track will be directly tied to the existing rail without an interlocking. Caltrain service will stop at the existing 22nd Street Station; however, there is no passing track provided in this alternative to allow express trains to pass station dwelling Caltrain trains.

### 4.3 HSR Operations

High-Speed Rail service will operate through the PAX corridor with planned station stops at Fourth and Townsend Street and the Salesforce Transit Center. HSR trains will not stop at the current 22nd Street Station, and HSR stops are not planned at a potential future, relocated station within the PAX project limits.

- **Alternative A1/A2 – Long Alignment:** A new interlocking near Cesar Chavez Street will be provided to redirect trains traveling in both directions from the current rail alignment to the west and into a new tunnel portal near 25th Street and Pennsylvania Avenue. Trains will remain in this new tunnel for the remaining length of the PAX project and will enter the Fourth and Townsend Street Station at the interface with the DTX project in the area of 6th Street and Townsend Street. HSR trains will not stop at a mid-PAX station; however, there is no passing track provided in this alternative to allow HSR trains to pass station-dwelling Caltrain trains.
- **Alternative B1/B2 – Mid-Length Alignment:** Southbound trains will tie into the existing blended rail system south of Tunnel 2 through an interlocking near Cesar Chavez Street. Northbound trains will remain on the existing blended system tracks north through Tunnel 2 and will tie into new the PAX system through an interlocking inside Tunnel 1 near the existing south portal. HSR trains will operate in a new tunnel for the full length of the PAX project and will enter the Fourth and Townsend Street Station at the interface with the DTX project in the area of 6th Street and Townsend Street. HSR trains will not stop at a reconfigured, at-grade 22nd Street Station. No passing track will be provided for southbound trains, but northbound trains could use the existing northbound tracks through the 22nd Street Station to pass dwelling Caltrain trains since a new, third set of tracks will be provided through the 22nd Street Station area. The extent of passing tracks would be from the north portal of Tunnel 2 to the south portal of Tunnel 1. Crossovers could be provided beyond each end of the passing to allow southbound High-Speed Rail trains to also access the passing track through the 22nd Street Station by locally crossing over to the northbound tracks. On the north end, this crossover exists on Alternative B2 to meet fire/life safety criteria; on Alternative B1, an additional crossover could be added. On the south

end, a crossover at Cesar Chavez Street (which is an existing Caltrain control point at Cesar Chavez Street) could be included.

- **Alternative C – Short Alignment:** Southbound tracks will tie into the existing blended rail system through a new interlocking between the south portal of Tunnel 1 and the 22nd Street Station. Southbound trains will continue in a new PAX tunnel for the remaining length of the PAX project and will enter the Fourth and Townsend Street Station at the interface with the DTX project in area of 6th Street and Townsend Street. The northbound tracks will tie into the existing blended system at the north portal of Tunnel 1 near Mariposa Street. The northbound track will be directly tied to the existing rail without an interlocking. HSR trains will not stop at the existing 22nd Street Station; however, there is no passing track provided in this alternative to allow HSR trains to pass station dwelling Caltrain trains.

#### 4.4 Downtown Rail Extension (DTX)

The blended PAX service will tie into the future underground DTX system just south of the future Fourth and Townsend Street Station. Coordination with the DTX project was conducted to optimize this interface. This interface includes a four-track configuration south of the Fourth and Townsend Street Station whereby PAX construction and revenue service in a completed DTX can proceed concurrently. This configuration also shows that it is feasible to connect via a stub track to the future subsurface railyard. These elements are expected to significantly minimize service interruption to the Salesforce Transit Center to accommodate the installation, testing, and commissioning of PAX.

The cut-and-cover tunnel for northbound trains for Alternative C will be east of the DTX ramp at the railyards. This cut-and-cover tunnel will cross under the surface rail connection to the railyards. Methods of installation that could minimize or eliminate impacts to rail operations should be researched during the next design phase; otherwise, a temporary shutdown of existing tracks will be necessary. Coordination with the DTX project will be needed to accommodate a tie-in for this cut-and-cover tunnel because the tie-in configuration is different than for Alternatives A and B.

#### 4.5 Railyards

Caltrain operates the 4th and King Station and the existing railyard to the east of the interface between PAX and DTX. This railyard is subject to future development, and several possible scenarios must be accounted for to ensure the PAX project is able to accommodate access to all potential future railyard configurations. Those possible configurations include the following:

- The railyard remains in its current configuration at the surface.
- The railyard remains at the surface but is shifted to terminate at 5th Street.
- The railyard is depressed below grade with access from the south only.
- The railyard is depressed below grade with access from both the north through a DTX connection and the south through a PAX connection.
- The railyard is reduced in size.

Timing for railyard development is uncertain, so the PAX project should account for multiple scenarios for phasing of the railyard and PAX. For example, PAX may be initially operated to provide access to a surface railyard but should be able to accommodate development of depressed railyard access with minimal disruption to revenue service.

The decision of whether to keep or remove at-grade rail tracks after project completion has not yet been made. It is assumed in this section that the at-grade rail tracks that are not removed as part of the PAX construction would remain after projection completion. Alignments A1, A2, B1, and B2 provide rail access to the current at-grade rail yards through the following rail movements:

- Southbound trains: Southbound trains would access railyards via the DTX ramp, cross Mission Bay Drive at grade, reverse at the DTX at grade siding under I-280 and enter the railyards.
- Northbound trains: Northbound trains would access the at-grade rail yard using the existing track from the southern interface of PAX as a railyard lead. Specific movements for each Alternative are as follows:
  - For Alternatives A1 and A2, the interface of the rail yard lead would occur just north of Cesar Chavez Street. Northbound trains would pass through existing Tunnels 2 and 1 and would cross 16th Street and Mission Bay Drive at grade to access the at-grade rail yard.
  - For Alternatives B1 and B2, the interface of the rail yard lead would occur just north of 22nd Street Station. After proceeding through the existing Tunnel 2 and 22nd Street Station, Northbound trains would remain in the existing Tunnel 1 instead of entering the PAX tunnels and would cross both 16th Street and Mission Bay Drive at grade to enter the surface rail yards.
  - If at-grade tracks are removed, northbound trains in Alternatives A1, A2, B1, and B2 would need to use the same movements as outlined below for northbound trains in Alternative C.

See Figure 4-1 for the rail yard connection train movement schematic for Alternatives A1 and A2 at surface rail yard tie-in.

Alternative C southbound railyard access is the same as the other alternatives. This alternative does not provide direct at-grade railyard access for northbound trains because the northbound decline section just north of existing Tunnel 1 would block at-grade train movement between the north portal of Tunnel 1 and 16th Street. Alternative C northbound trains would have to proceed to the Fourth and Townsend Street Station and reverse up the current DTX incline to grade and then reverse again to access the at-grade rail yard.

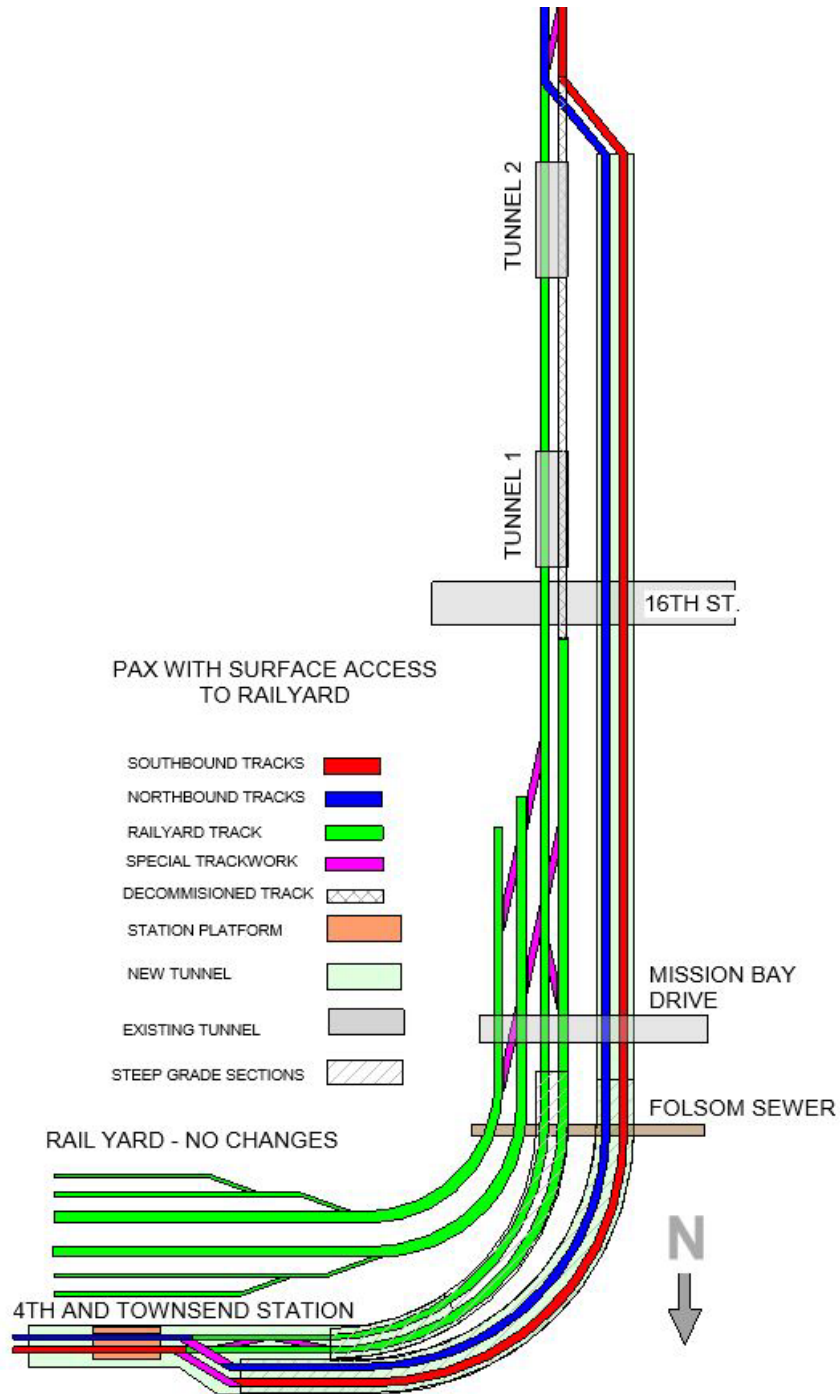

Figure 4-1. Surface Railyard Access Schematic for Alternative A1/A2

#### 4.6 Rail Service Implementation

Blended rail service through the PAX project limits will need to be tested and commissioned prior to revenue service. This process typically takes 120 days. To minimize disruption to the current revenue service, trains should still be able to operate on the existing blended system while testing and commissioning is done on the PAX project during nonrevenue hours. The DTX interface has been

optimized to allow for operation of DTX while PAX is tested and commissioned. However, for Alternative C, multiple in-service tracks must be permanently removed from service to allow for the PAX northbound track installation and operation. Service implementation at the DTX interface is under development, so this section will focus on how service can be implemented at the southern limits of the project for each major alignment alternative to minimize service disruption.

#### **4.6.1 Alternative A1/A2 – Long Alignment**

The interlocking for both train directions of PAX will occur near the Cesar Chavez grade crossing and can be installed during a weekend shutdown to allow trains to switch over from the current system to PAX. This will allow revenue service to continue on both blended rail tracks while commissioning is performed on both PAX tracks during nonrevenue hours. Because both PAX tracks can be commissioned together, the commissioning schedule can be compressed and revenue switchover for both northbound and southbound trains can happen together.

#### **4.6.2 Alternative B1/B2 – Mid-Length Alignment**

The southbound PAX alignment will run through the abandoned Tunnel 2, west of the current alignment, and be connected to the existing blended rail system with an interlocking south of the existing Tunnel 2. The southbound PAX trains will be commissioned first during nonrevenue hours while the current blended system continues revenue service (see Figure 4-2.). An interim implementation phase will then be required where PAX operates revenue service for southbound trains through the new PAX tunnel under Potrero Hill while the northbound PAX tunnel connection into existing Tunnel 1 is completed during night and weekend shifts. During this interim phase, northbound trains will continue to operate on a single track through existing Tunnels 1 and 2. When the northbound PAX tunnel tie-in is complete, the existing interlocking south of Tunnel 2 at Cesar Chavez will be used to shift northbound trains being tested for commissioning from the current northbound tracks to the current southbound tracks (shifting PAX trains undergoing commissioning from MT1 to MT2 while continuing northbound revenue on MT1). This will allow revenue trains to continue to operate through Tunnel 1 while testing and commissioning for northbound trains is completed during night and weekend outages. The 22nd Street Station can remain in operation during the interim phase, with northbound trains remaining on the current northbound tracks and access continuing via the existing east platform. In the interim phase, southbound trains will be accessed from an extension to the existing southbound platform with passengers boarding the trains from the east. This platform will become a center platform serving both northbound and southbound trains when PAX is in revenue service.

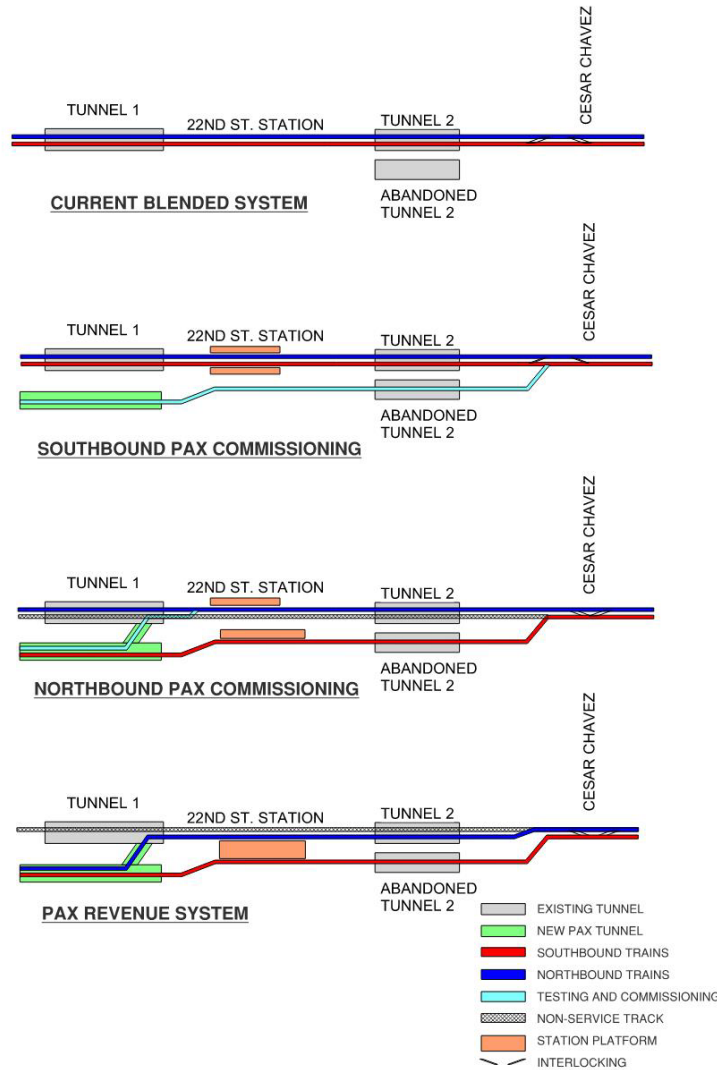
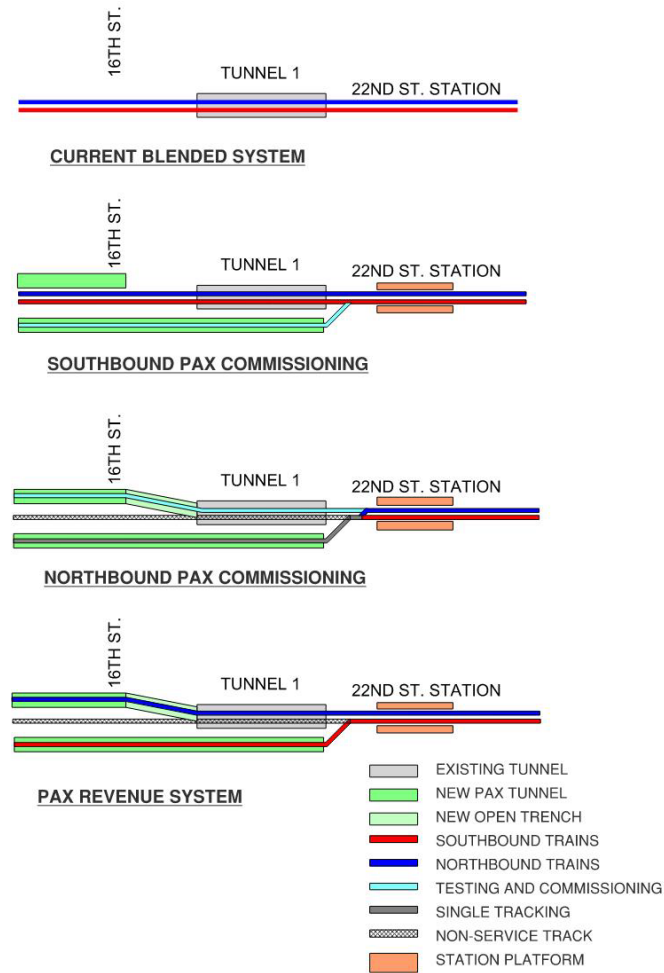

Figure 4-2. Alternative B1/B2: PAX Commissioning and Revenue Service

#### 4.6.3 Alternative C – Short Alignment

The southbound PAX tunnel under Potrero Hill will connect to the current blended alignment southbound train with an interlocking just north of the current 22nd Street Station. This interlocking can be installed during a weekend closure and will be used to test and commission southbound PAX trains while the current blended alignment remains in revenue service (see Figure 4-3.). Once southbound commissioning is complete, an interim phase will be required where both northbound and southbound trains are singled tracked though the new PAX between 22nd Street Station and the tie-in with DTX. The distance of single tracking is approximately 1.1 miles. Single tracking will be required while a 1,100-foot-long U-wall trench is constructed north of the Tunnel 1 portal. Single tracking refers to routing both northbound and southbound trains on a single track for a given section. The U-wall trench will tie into a new cut-and-cover tunnel that runs under the Caltrans I-280 viaduct. The cut-and-cover tunnel will run to the east of the current at-grade alignment. The cut-and-cover tunnel from the DTX tie-in at the north to the south side of 16th Street can be constructed concurrently with the TBM tunnel under 7th Street. Both the TBM and cut-and-cover tunnels can be built while trains are operating on the current blended system. Single

tracking during construction of the trench section and commissioning of the northbound PAX system are expected to be needed for nine to twelve months. Once northbound commissioning is complete, PAX service will be implemented in both directions.



**Figure 4-3. Alternative C: PAX Commissioning and Revenue Service**



## 5.0 Rail Infrastructure and Systems

Figure 5-1 through Figure 5-5 identify on a conceptual basis where key rail and fire/life-safety infrastructure that is discussed in this section could be located for each of the alignments.

### 5.1 Fire/Life Safety and Ventilation

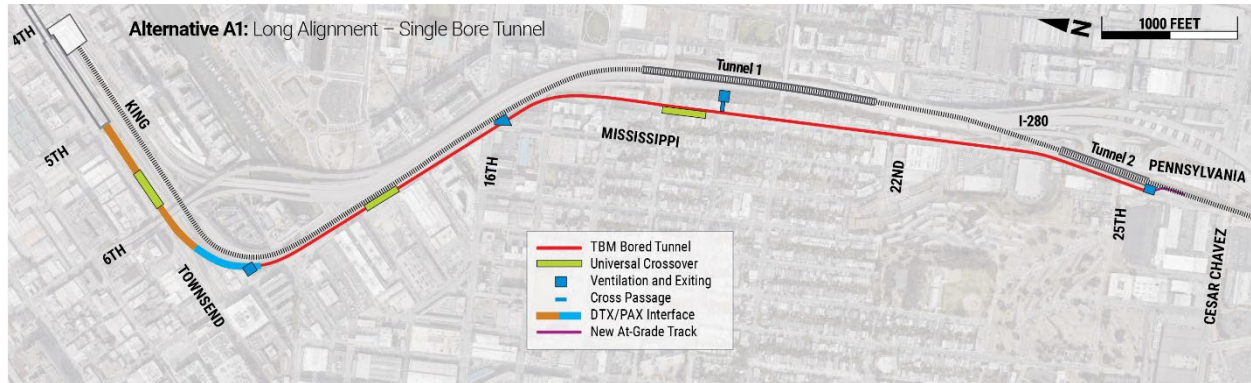

Figure 5-1. Fire/Life Safety Features for Long Alignment – Single Bore Tunnel

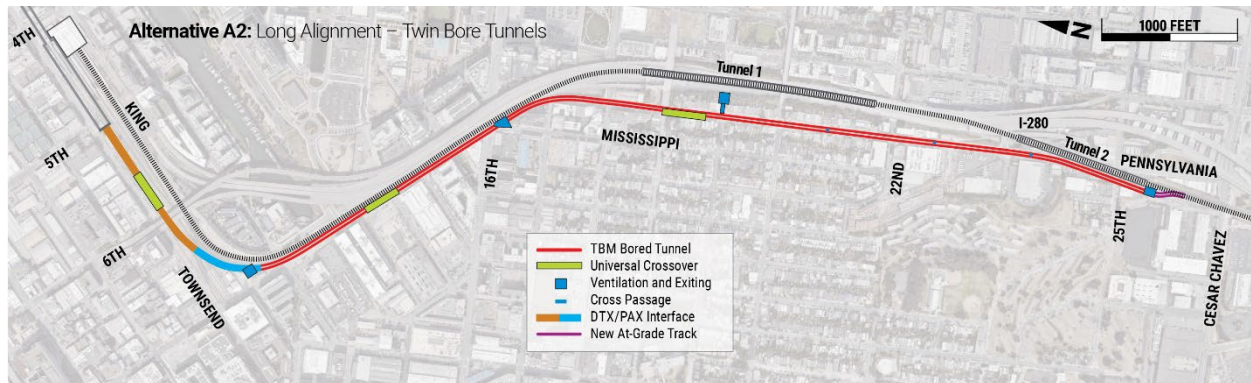

Figure 5-2. Fire/Life Safety Features for Long Alignment – Twin Bore Tunnels

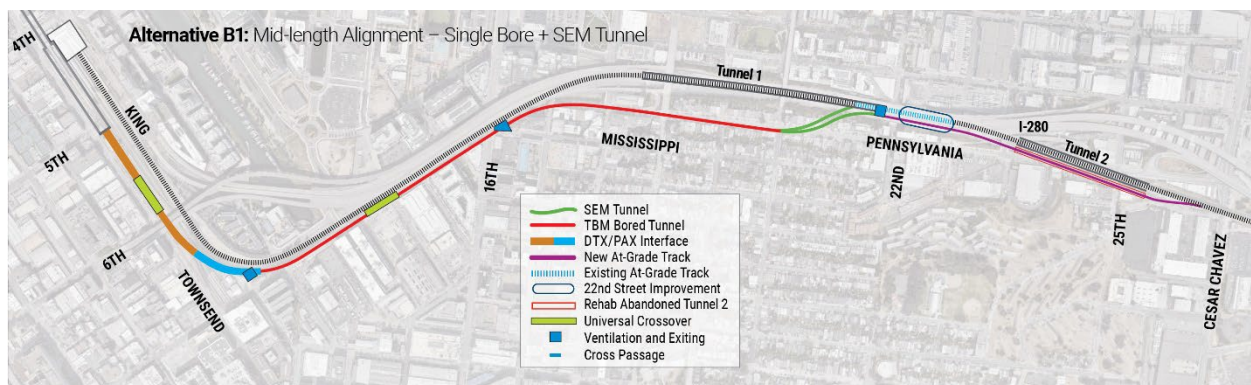
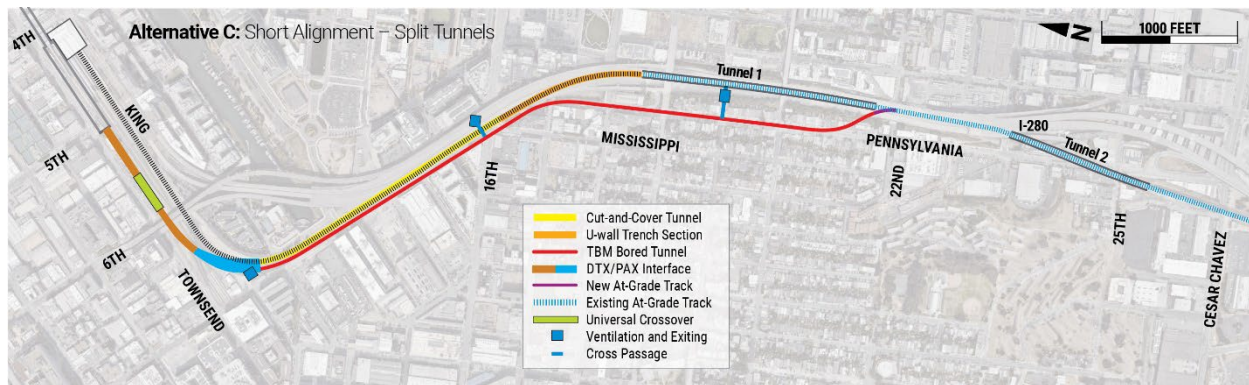

Figure 5-3. Fire/Life Safety Features for Mid-Length Alignment – Single Bore + SEM Tunnel



**Figure 5-4. Fire/Life Safety Features for Mid-Length Alignment – Twin Bore + SEM Tunnels**



**Figure 5-5. Fire/Life Safety Features for Short Alignment – Split Tunnels**

The basis for tunnel ventilation and exiting includes the National Fire Protection Association Standard for Fixed Guideway Transit and Passenger Rail Systems (NFPA 130) as well as requirements for the Caltrain and High-Speed Rail Blended System.

**Ventilation Zones:** NFPA 130 requires that no more than one train in each direction should occupy a ventilation zone at a given time. The maximum spacing of ventilation zones through the PAX alignment assumes a minimum operating speed of 25 mph and a minimum operating headway of 2 minutes. Based on these criteria, ventilation zones should be no more than 4,400 feet apart.

Tunnels shorter than 300 feet do not require mechanical ventilation. Tunnels between 300 feet and 1,500 feet long are assumed to be ventilated using jet fans placed at regular intervals since this a more cost-effective method for venting shorter tunnels. Longer tunnels will require conventional fan plants spaced at no greater than 4,400 feet.

**Exiting Facilities:** Exiting facilities are intended to meet the criteria of NPFA 130 and the Caltrain and High-Speed Rail Design Criteria. These requirements call for cross passages spaced at a maximum of 800-foot centers where twin bore tunnels are used or where a central divider wall provides separation between northbound and southbound tracks. Alternatively, dedicated exiting facilities that lead directly to the surface are permitted at 2,500-foot maximum spacing.

**Crossovers:** Where crossover tracks in the tunnels create a gap in the separation wall between tracks, we have assumed for this study that the separation wall is ineffective between ventilation facilities, and therefore dedicated exiting facilities are required at 2,500-foot spacing around track crossovers.

**Ventilation Facilities:** Ventilation facilities are identified for each alternative in Figure 5-1 through Figure 5-5. Mid-tunnel ventilation facilities will consist of above-grade exhaust structures constructed within a shaft excavated over or adjacent to the train tunnel with adit connections between shaft and rail tunnel(s) to exhaust smoke and provide emergency egress. At tunnel portals, these facilities will be at-grade with ventilation louvers placed above the tunnel portal.

Mid-tunnel ventilation facilities are significantly more expensive than portal facilities because of the additional underground work required. Mid-tunnel facilities also have greater right-of-way impacts because above-grade structures require right-of-way takes while portal facilities are generally placed above the existing rail right-of-way.

**Blue Light Stations:** Blue Light Stations (BLSs) will be provided at approximately 800-foot spacings along the tunnel walkways. The BLSs will be configured to permit a patron during an emergency situation to activate an emergency shutdown of the overhead contact system and to contact the Central Control Facility (CCF) via an emergency telephone.

## 5.2 Traction Power Electrification

Both Caltrain EMU trains and High-Speed Rail trains will operate via a 25 kV overhead catenary system power. Caltrain is currently completing electrification of the entire system. Upon completion, existing traction power facilities can be reconfigured to provide power for the PAX project alignment.

**Overhead Catenary Systems (OCS):** In tunnels, overhead catenary wires will be supported by drop tubes connected to the concrete tunnel lining. In addition, Autotransformer Feeder Cables and static wires will also be routed through the tunnel, supported on tunnel linings or drop tubes. Motorized disconnect switches will be provided at crossovers and tie-in locations to enable sectionalization of the OCS for maintenance and in the event of outages.

**Tie-in to Caltrain Electrification System and DTX:** The PAX OCS will tie into the existing Caltrain Electrification system near Cesar Chavez Street. New traction power feeder cables will extend from the existing 25 kV Paralleling Station No. 1, near Mariposa Street to the PAX tunnel. The PAX OCS will tie into the DTX OCS in the stub track area south of the proposed underground DTX Station at Fourth and Townsend Street.

## 5.3 Communication

Communications systems will be provided for the PAX alignment and tunnel. The major communications subsystems will include:

- Extension of the Caltrain fiber optic backbone system through the tunnel with network switching equipment provided in each signaling room, ventilation plant, and related facilities.
- Closed circuit television (CCTV) to monitor tunnel portals and emergency exits.

- Intrusion detection for PAX facilities.
- Station communications subsystems at a modified or new 22nd Street Station.
- Emergency telephone for Blue Light Stations.

The PAX communications systems will be compatible with Caltrain’s headend communications systems at the CCF. It is anticipated that some modifications to existing software databases and minor expansion of hardware may be needed at CCF to accommodate PAX.

## 5.4 Track and Switches

Both Caltrain and High-Speed Rail operate on standard-gauge tracks. In tunnels, track will be the continuously welded type with the tracks connected to the invert with concrete plinths and direct fixation fasteners. This is the same track structure system used in the DTX project. At-grade track will be standard ballasted track on concrete ties.

**Special Trackwork:** Track switches allow trains to move from one set of tracks to another and provide flexibility for operation during maintenance service disruptions. The PAX alignment alternatives provide up to three crossover switches along the alignment. Fewer crossover switches are used where the tunnel is shorter or where it is not feasible to provide three crossovers. The following is a breakdown of indicated crossovers by alignment alternative. In order to facilitate switchover from the DTX to PAX at their interface, the DTX could install special trackwork to transition to PAX and an appropriate length of trackway in the tunnel stub at the time of DTX construction.

- Alternative A1 – Three Crossovers
- Alternative A2 – Two Crossovers
- Alternative B1 – Two Crossovers
- Alternative B2 – Two Crossovers
- Alternative C – One Crossover

## **6.0 Geotechnical and Hydrology**

### **6.1 Geotechnical Study and Tunneling Considerations**

#### **6.1.1 Approach**

The Geotechnical Study Report (MJ/Slate, 2022b) presents the results of preliminary geotechnical studies carried out along the PAX project corridor. The purpose of the preliminary study was to identify potential geologic and geotechnical constraints along the PAX project. This Geotechnical Study Report provides a detailed review of background information including existing geotechnical reports for facilities near the proposed alignments, laboratory testing, geologic maps, and other readily available information pertaining to the project. The information gathered from the study was used to prepare geologic cross sections, preliminary geotechnical properties, and recommendations regarding tunneling feasibility.

The Geotechnical Study Report was limited to a desktop study and site walks and did not include field explorations such as borings or geophysical surveys. Geotechnical reports from the San Francisco Department of Building Inspection (SFDBI) were obtained. Because of time constraints related to the closure of the DBI during the pandemic, reports requested from the SFDBI focused on areas along the alignment where there were gaps in available data and areas near contact points of surficial geologic units, and do not represent the full alignment. The Geotechnical Study Report concludes with recommendations for additional investigations to be considered to support future planning, design, and construction evaluations for the project. The Geotechnical Study Report is presented in Appendix D.

#### **6.1.2 Summary of Findings**

The following sections summarize the anticipated subsurface conditions along the alignment corridor. The geologic constraints and key geotechnical tunneling considerations were characterized in three segments (North, Central, and South), as shown in Figure 6-1. For Alternative A1, the North Segment is the longest segment and spans approximately 4,000 feet, from Station 1001+00 to Station 1041+00. The Central Segment covers an area between Station 1041+00 and Station 1057+00 for a total of 1,600 feet. The South Segment is approximately 2,900 feet long, from Station 1057+00 to Station 1086+00.

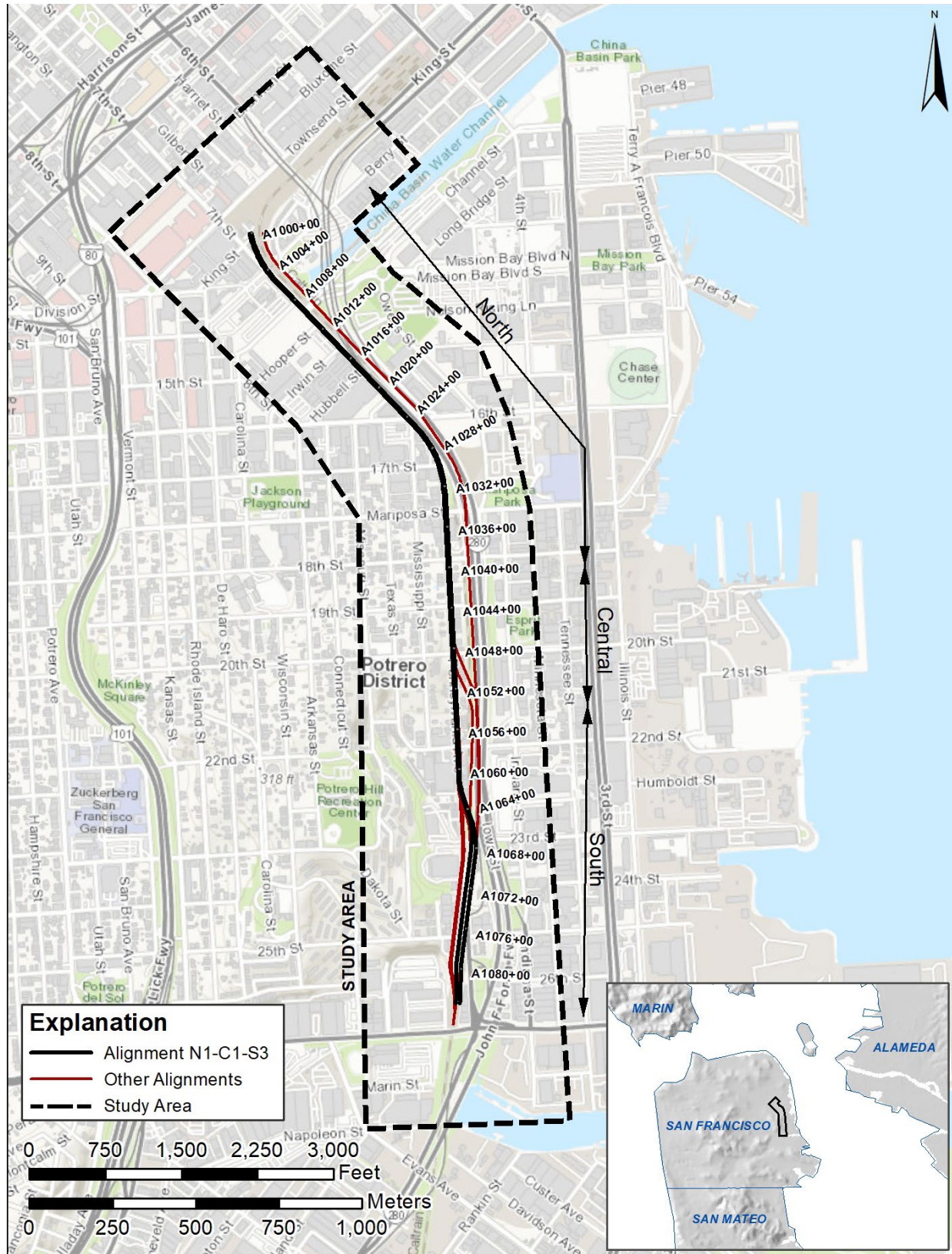

### 6.1.2.1 North Segment

The Geotechnical Study found the North Segment is located in an area mapped as artificial fill and, depending on the final alignment, is expected to encounter artificial fill, Young Bay Mud, Colma Sand, and Franciscan Complex bedrock. The entire length of the tunnel within the North Segment will be located below the anticipated groundwater level. Potential geotechnical hazards include liquefaction of the artificial fill and disturbed Colma Sand during and after strong ground shaking. Lateral spreading caused by liquefaction of the artificial fill could also occur in areas of gently sloping ground.

Key tunneling considerations within this segment include effects of soil strength loss and potential for tunnel uplift in areas where liquefiable materials are present. Potential tunnel construction risks include mixed-face conditions, ground settlement, ground heave, presence of contaminated soils and groundwater, and damage to nearby existing foundations and other buried structures. Groundwater control measures will also need to be considered for design and construction for portal and cut-and-cover sections. The current tunnel alignments will also encounter a variable bedrock surface that is generally rising towards the ground surface as the alignment extends from the North Segment to the Central Segment. Design of excavation support systems for cut-and-cover excavations in this area will need to account for this variability. Tunnel excavations will need to plan for mixed-face conditions consisting of soft soils overlying bedrock and the associated settlement risks that accompany these conditions.

### 6.1.2.2 Central Segment

The Central Segment is located in an area mapped as Franciscan Complex bedrock, primarily consisting of sandstone with local serpentinite. Alignment alternatives are anticipated to encounter only rock along the full segment length. Subsequent site-specific investigations should seek to identify the depth and extent of sandstone and serpentinite bedrock along the alignment in addition to other rock that may be encountered, as well as to determine more refined strength and durability properties to guide design specifications and tunneling equipment. Locally, serpentinite could include naturally occurring asbestos (NOA).

Potential tunnel construction risks include mixed-face conditions (both soil and rock encountered in the tunnel face at the same time during mining), ground settlement in areas where ground cover is low, and excavation-induced vibrations when mining near existing structures. Groundwater control measures will also need to be considered for design and construction of tunnel and portal structures. The existing bedrock may act as a groundwater barrier where water may effectively pool against the bedrock. Because the Central Segment will include relatively deep tunneling through rock, groundwater may be expected during construction and can likely be handled with standard drainage measures within excavation, such as collection piping and sumps. Portal structures will also need to consider the presence of groundwater and will likely require drainage measures such as geotextiles, drainage mats, and collection drains.

### 6.1.2.3 South Segment

The South Segment is in an area mapped as serpentine Franciscan Complex bedrock with local areas of artificial fill, Young Bay Mud, and/or Undifferentiated Quaternary Soils. Bedrock is likely to include serpentinite and shale. Available subsurface information regarding depth and lateral extent of soil units is relatively sparse; depth and extent of surficially mapped rock types are also unknown. While the geologic

profile for the South Segment provides a general understanding of the geology along the segment, subsequent investigations should seek to better characterize the subsurface conditions, depths of soil units, and rock types expected to be encountered. Locally, serpentinite in this reach could include NOA.

Potential tunnel construction risks include mixed-face conditions, ground settlement, and excavation-induced vibrations when mining near existing structures. Groundwater control measures will also need to be considered for design and construction of tunnel and portal structures. Groundwater may be relatively shallow in areas of soil, which may result in groundwater being encountered during excavation, particularly in areas where an open crown and shallow earthwork are expected; groundwater control measures will need to be considered for these areas. Portal structures will also need to consider the presence of groundwater and will likely require drainage measures such as geotextiles, drainage mats, and collection drains.

### **6.1.3 Geologic Constraints and Considerations**

As mentioned above, potential geologic hazards include liquefaction and lateral spreading of artificial fill and Colma Sand disturbed during construction. Subsequent investigations should seek to characterize the extent and depth of artificial fill along the North and South Segments, as well as investigate more refined estimates of residual strength of disturbed Colma Sand. Volatile organic compounds also may be present in the artificial fill, and site-specific testing is recommended to be performed to characterize possible locations of hazardous materials.

For rock, serpentinite could include NOA and heavy metals, which pose significant hazards to humans when airborne or ingested. Subsequent investigations should seek to identify locations and extent of serpentinite along tunneling locations, and testing for NOA and heavy metals should be performed to inform mitigation and remediation measures during construction.

Groundwater control measures will need to be considered for areas of shallow groundwater encountered in portal and cut-and-cover sections in the North and South Segments. Groundwater control measures for tunneling in rock should also be considered. Use of watertight excavation support systems for deep excavations and use of pressurized-face TBMs and gasketed precast concrete segments for tunnel excavation will be required where shallow groundwater is encountered in the portions of the project excavated in soil.

Tunnel and portal excavations within sections of the Central Segment that are anticipated to be within Franciscan Complex bedrock can likely control groundwater through the use of localized measures, such as sumps installed within excavations. Permanent structures in this area will likely require the use of waterproofing or drainage measures to ensure the structures remain dry and maintenance free during track operation.

### **6.1.4 Tunneling Considerations**

Based upon the existing geologic and geotechnical information, the subsurface conditions along the PAX project corridor are suitable for tunneling methods. In areas of soft ground below the groundwater table, tunneling methods that utilize positive support measures, such as pressurized-face tunnel boring machines (TBMs), will be necessary to support the ground during excavation. In areas of Franciscan Complex



bedrock and where stable soils are anticipated, the sequential excavation method (SEM) and TBM tunneling in open mode are considered feasible methods of tunnel construction.

Although preliminary studies suggest that conditions are suitable for tunneling, there are several challenges that will require further study as part of subsequent project phases, including:

- Evaluation of liquefaction and lateral spreading potential
- Effects of ground shaking on underground structures resulting from earthquakes
- Extents of Young Bay Mud within the proposed tunnel alignment
- Presence and extents of existing structures along the alignment, including deep foundations and buried utilities
- Location of the bedrock surface and extents of potential mixed-face tunneling
- Existing surface constraints in areas of low ground cover and risks associated with unanticipated excess settlement of the ground during tunnel construction
- Presence of ground and groundwater contamination, including NOA within Franciscan Complex bedrock
- Potential for vibrations and ground settlement induced by tunneling and other underground excavations (i.e., portals and break-ins to existing tunnel infrastructure)

Given the dense urban corridor and challenging geologic conditions anticipated along the PAX project corridor, it is anticipated that significant additional subsurface investigations will be needed to better characterize geotechnical conditions and to assist in evaluating the tunneling methods discussed in this report.

## **6.2 Hydrology**

### **6.2.1 Approach**

A preliminary hydrology study was prepared to identify the geologic and hydrologic setting and expected groundwater conditions along the PAX corridor (MJ/Slate, 2022a). The hydrology study considered influences of historical alteration of hydrogeologic features in the project's vicinity, existing groundwater levels and flow direction, and possible future conditions under modeled sea level rise scenarios. Sea level rise of 3.4 feet is projected for the end of the century, which is near the conclusion of the project's anticipated lifespan. The study provided recommendations for the project's excavation and construction methods, and generally identifies potential impacts on groundwater systems, such as groundwater drawdown, induced settlement, alteration of subsurface flow direction, and the potential for release of contaminants into groundwater.

The study was completed by reviewing hydrologic information along the PAX corridor including hydrologic setting, sea level projections, groundwater sensitive areas, and sources of groundwater contamination. Known groundwater level data were compiled from nearby subsurface investigations and geotechnical reports. The study was limited to a desktop study and did not include field explorations such as borings or geophysical surveys. This study also provides a preliminary review of expected groundwater

conditions. Further evaluations should be completed in subsequent project phases. The Hydrology Study is presented in Appendix E.

### 6.2.2 Summary of Findings

The Hydrology Study Report primary findings include the following:

- Groundwater along the northern portion of the project corridor is generally shallow (nearest to the ground surface), deepens as the alignment extends through the topographic high of Potrero Hill, and becomes relatively shallow again in the southern portion near Cesar Chavez Street.
- Sea level rise is most likely to impact the area of the project that is in close proximity to the Mission Creek Channel. Construction in this area may require additional pumping to ensure the tidal water from the San Francisco Bay and potential higher groundwater table do not affect the excavation/mining of the tunnel. Design of permanent structures will need to account for potential sea level and its potential effects on groundwater levels adjacent to the Bay margins.
- Potential settlements due to construction dewatering should be assessed by considering historical changes in soil-effective stresses caused by human and natural activities, including seasonal and tidal variations, and other dewatering activities around the site. If groundwater levels are expected to be lowered below the lowest historical range, ground settlements should be expected, particularly where groundwater levels within the Young Bay Mud soils are affected. Temporary excavations will have to be designed to prevent the inflow of groundwater and subsequent drawdown and ground settlement of the surrounding soils.

The extent of the longest PAX project alignments is almost entirely within areas that are either contaminated or suspected of being contaminated (MJ/Slate, 2022a). Of primary concern is that excavation and groundwater control of the project could mobilize contaminants in the soil or groundwater. These areas would be subject to requirements pursuant to San Francisco Public Health Code Article 22 (Maher Ordinance), administered by the Department of Public Health. Dewatered groundwater should be tested for contaminants and contaminated groundwater should be pumped and treated at treatment plants, prior to discharge. Possible impacts on groundwater quality could also occur as a result of groundwater drawdown. Issues include the potential for existing groundwater contamination to mobilize toward the project and/or into previously unaffected areas. Groundwater acidification (associated with mobilization of contaminants) could compromise underground structures.

Groundwater quality could also become degraded because of saline water intrusion from nearby estuaries and coastal waters or as a result of construction-related surface spills. Because of the likely presence of contaminated groundwater in the area, handling of groundwater and saturated soils/rock will likely require special treatment before discharge or disposal at approved facility. A gasketed, precast concrete tunnel lining design installed during mining is one way to minimize water intrusion into the tunnel and mitigate this risk.

## **7.0 Tunneling and Constructability**

### **7.1 Construction Methods**

#### **7.1.1 Tunneling Methods**

Typical tunneling methods and construction requirements that were used in the development of the conceptual tunnel alignments, cost estimates, and schedules are described here in more detail. Various elements of construction means and methods, including tunnel excavation method and shaft support approach, are often left to the contractor to select. However, in some cases it may be necessary to restrict construction methods to preclude those that are determined to have unacceptable risks or impacts. Given the anticipated ground conditions and the history of tunneling in the area, it is likely that several methods are acceptable for a given project element. The construction methods described herein, therefore, are not the only feasible ones, but were selected by balancing risk, cost effectiveness, and industry practice.

Based on the available geologic data, the project team anticipates that the proposed tunnel alignments will be constructed within a mix of soil and weak rock units below the groundwater table, including mixed-face conditions in some locations. In general, the northern section of the project is located in soils, and the southern section in weak rock.

##### **7.1.1.1 TBM Mining**

There are several types of TBMs, and technologies have advanced significantly since the first uses. For this project, a closed-face shielded TBM capable of applying pressure to the full face of the excavation (i.e., a soft ground TBM) will be required where mining soil and weak rock below the groundwater table is anticipated.

Closed-face TBMs are designed to apply pressure at the tunnel face to maintain stability of the excavation in soft or unconsolidated ground, or in ground that requires positive face support to prevent ground movement around the excavation. There are two major types of closed-face TBMs: earth pressure balance TBMs (EPB TBMs) and slurry TBMs. Closed-face TBMs are typically designed for excavation of soils below the groundwater table, where active face pressure is needed to prevent water inflows or prevent excessive ground movement that can lead to large surface settlements and potential damage to existing utilities and structures.

Further evaluation of a preferred TBM type will be needed as the project design advances and additional subsurface information is collected. Final selection of the preferred closed-face TBM type will require consideration of additional factors that are beyond the scope of this study. Some key considerations that will need to be evaluated include the availability of construction staging area, required TBM size, anticipated soil gradation, depth of cover above the tunnel, and groundwater conditions. An example of a closed-face TBM is shown below in Figure 7-1 (Herrenknecht, n.d.).

For closed-face TBMs, a tunnel lining system must be assembled and installed within and behind the tunnel shield as shown in Figure 7-1. The tunnel lining typically consists of a segmental precast concrete lining with the segments connected by steel bolts. The segments are typically fabricated off site at a precast concrete yard where high quality control standards are maintained and delivered to the site. The

segments have a gasket system to provide an impermeable seal to prevent infiltration of groundwater and are typically designed to accommodate seismic demands from strong ground shaking. Depending on staging area size, there is typically at least a few days' supply of segments stored on site, where they are hoisted down to tunnel level, transported to the tunnel heading, and installed in place with a mechanical arm in the TBM that has been specifically designed for this purpose. The segments are bolted into place by tunnel workers. For the purposes of this study, a 24-inch-thick lining has been assumed for the 42-foot OD single bore alternatives and a 12-inch-thick lining for the 26-foot OD twin bore alternatives.

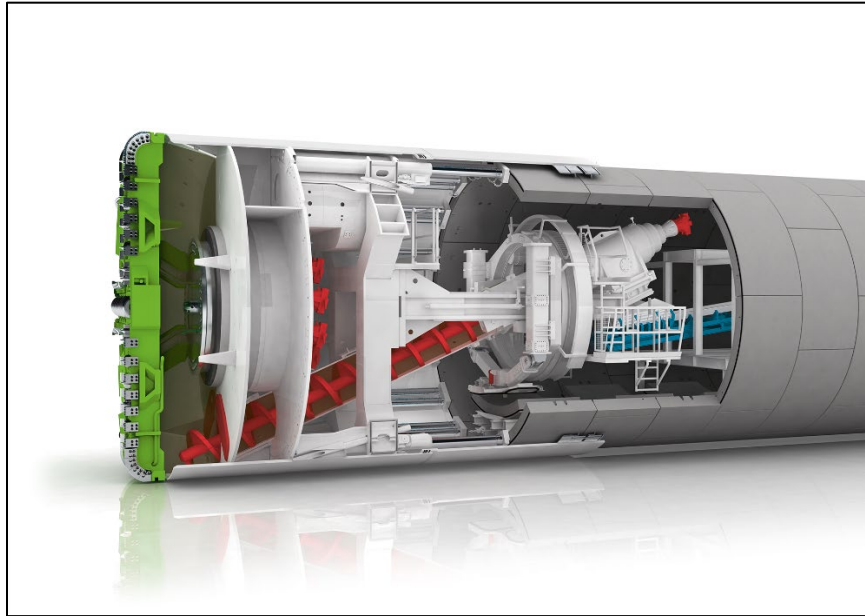

**Figure 7-1. EPB TBM (source: Herrenknecht)**

#### **7.1.1.2 SEM Mining**

The Sequential Excavation Method (SEM), also known as the New Austrian Tunneling Method (NATM), can be used to create underground excavations of varying geometry in ground that is expected to stand up long enough for support to be installed. The basic principle is to allow flexibility in how the tunnel excavation is supported based on real-time observations of the ground and installed support elements. To the extent that ground conditions permit, the inherent strength of the ground is used to facilitate economical excavation and installation of ground support as part of the mining process. Essentially, SEM tunnel excavation proceeds in incremental excavations using conventional mechanical equipment, such as an excavator, that is advanced forward a few feet at a time and installing ground support elements such as shotcrete, lattice girders, presupport, and other measures to maintain stability of the opening and limit ground movements. Adjustments are made to the initial ground support in real time based on actual ground conditions encountered and deformations in the ground support system. Once the excavation of the opening is complete and the full ground support system is installed, the resulting excavation is integrated into an overall ring-like support structure that is capable of carrying ground loads and maintaining a stable underground opening. Figure 7-2 below shows an example of an SEM excavation.



**Figure 7-2. SEM Construction Example, Showing Pipe Support Over Tunnel Crown and Sequentially Excavated Tunnel Drifts (Beacon Hill Station, Sound Transit, Seattle)**

The SEM method is most often employed where an underground opening is too short for TBM mining to be economical, where the permanent underground structure does not have a constant circular cross section, or when TBM mining is otherwise infeasible because of design requirements or other reasons (e.g., limited ground cover above the tunnel, limited staging area for TBM launching). This is the case for the PAX study where SEM mining is considered appropriate for connections from the TBM tunnel to the existing Caltrain track near 20th Street, and for cross passages, crossovers, and ventilation structure connections. The final tunnel lining for SEM mined tunnels typically consists of cast-in-place concrete.

### 7.1.1.3 Cut-and-Cover Methods

Cut-and-cover is the oldest method of creating underground space. The basic concept involves the digging of a trench, the construction of a concrete box structure, and the backfilling around and above the structure to return the surface to its original state. It is a disruptive technique with respect to the area around the trench, but depending on the depth of the excavation, often the most economical construction method. If the tunnel alignment is beneath a city street, the construction will cause significant interference with traffic, utilities, businesses, and other urban activities. The disruption, however, can be lessened through the use of staging, decking over the excavation to restore traffic, or by implementing what is called a top-down construction technique. Often on cut-and-cover projects in dense urban areas, surface construction is restricted to nights and weekends to avoid major traffic disruption but increases during normal weekday hours once decking is in place and traffic restored. While cut-and-cover is a technique usually reserved for relatively shallow tunnels, it is not uncommon to see it used at depths of around 60 feet, but rarely does it exceed 100 feet.

Cut-and-cover is used to construct tunnels for transport facilities, transit stations, underground structures, deep excavation for buildings, and water conveyance facilities. The cut-and-cover construction method can use various types of excavation support systems, including soldier piles and lagging, slurry walls, soldier piles in tremie concrete (SPTC) systems, tangent pile walls, jet grout walls, secant pile walls, soil

mix walls, and element walls. The method is significantly more complicated when performed below the groundwater table where dewatering cannot be performed and a watertight seal is required at the base of the excavation.

Temporary ground support may consist of soldier piles and lagging, sheet pile walls, secant piles, or tangent piles. Soil type, depth of groundwater, and feasibility of dewatering are all factors in the selection of temporary support type. Typically, temporary support does not contribute to the final structure's load-bearing support. When supports are permanent, these supporting elements are a part of the final structure and are designed to be left in place after the construction is complete. These include techniques like diaphragm (slurry) walls, secant piles, and tangent piles.

### **7.1.2 Cross Passages**

The need and purpose for cross passages are described in Section 5.1. For single bore alternatives, the need, location, and extent of wall dividers between two tracks in the single bores will be determined in later phases. Where divider walls exist in the single bore, and a cross passage is required, the installation is straightforward and consists of an access door to allow passage through the wall.

For twin bore options, the creation of a cross passage is more complicated. The passage has to be created by mining between the two tunnels. Figure 7-3 below shows an example of a cross passage between two running tunnels. In general, construction of cross passages in soft soils below the water table is the riskier operation, less so in soils above the water table, and least risky in rock that has some ability for self-support during mining. The sequence of this construction can vary but is essentially as follows:

1. Immediately around the planned passage location, the tunnel precast concrete lining is stiffened, supported, braced internally, or bolted to the ground to maintain the integrity of the tunnel lining system when a section of tunnel lining is removed to provide access to the ground behind the lining.
2. The ground between the two linings surrounding the passage is improved and presupported to control groundwater flow and the stability of the ground during mining. For soil this can likely be achieved through ground freezing, grouting, dewatering, spiling, or a combination of these. For rock, some of the same ground treatment methods and presupport can also be used.
3. An opening is cut into the tunnel lining exposing the ground to be mined for the cross passage.
4. The ground is mined using SEM techniques described herein.
5. A final concrete lining is cast in place; utilities and finishing architectural, mechanical, electrical, and ventilation systems are installed to complete the cross passage.

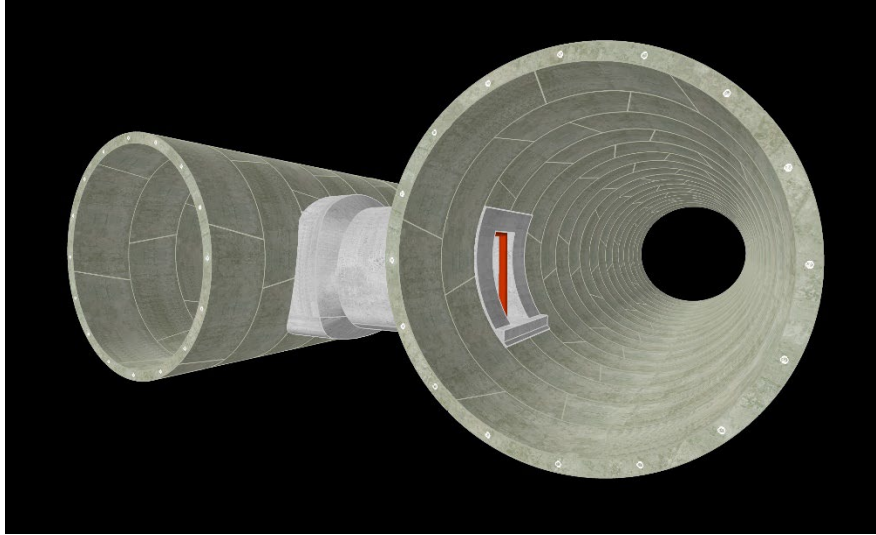

**Figure 7-3. Example of a 3D Rendering of a Cross Passage between Two Running Tunnels for a Subway (Northlink, Sound Transit)**

### 7.1.3 Track Crossover Sections

The need for track crossover sections is described in Section 5.1, and locations are given in Section 5.4. The difference between construction of track crossover sections between single bore and twin bore is similar to that for cross passages. Crossover sections in a single bore tunnel are straightforward and accomplished entirely within the single bore tunnel envelope without the need for any further excavation outside the tunnel. Crossover sections in a twin tunnel setting require the mining of the ground and creation of an open, supported area between the two tunnels for the entire length of the crossover. The methodology for twin bore tunnels is similar to that for a cross passage in that the tunnel lining adjacent to the opening must be strengthened, the ground to be mined must be pretreated using similar methods as described for cross passages, the ground is mined, and a final cast-in-place lining in the opened area between tunnels is placed.

Track crossover sections for twin bore tunnels will be several hundred feet long and will require a detailed SEM excavation sequence for the entire length to safely expose the ground between the two bored tunnels. As with cross passages, SEM mining in rock will be less risky than in soil.

The concept developed for a three-track layout on the DTX project, shown in Figure 7-4, involving twin bore TBM mining (red circles) with the center SEM mined (green stippled area), is a reasonable starting point for conceptual level planning on PAX and was used as a reference frame for the PAX twin bore track crossover sections. This approach was assumed in our cost estimate and schedule.

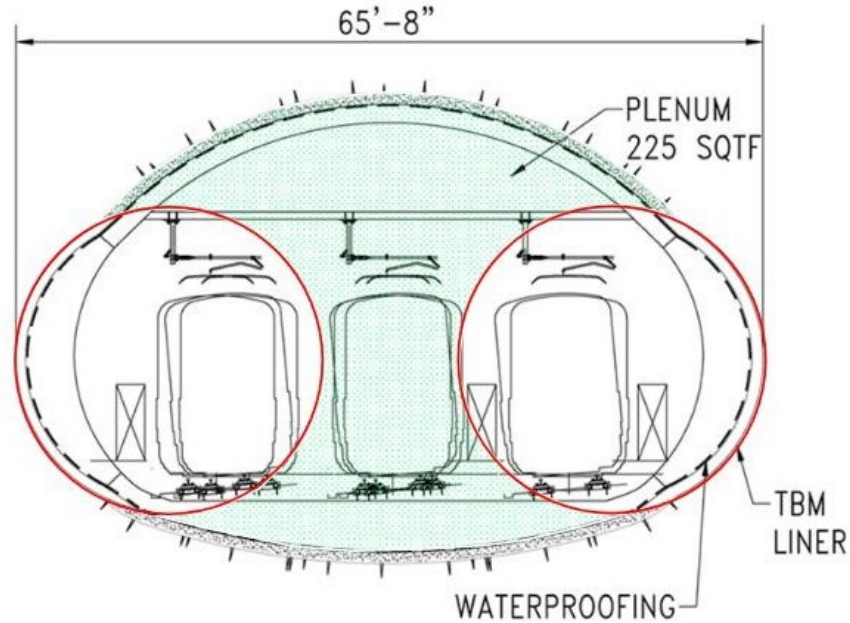

**Figure 7-4, Example of SEM Mining of Center Area between Two Running Tunnels to Create Space for a Track Crossover Section (TJPA, 2017)**

An example of a track crossover section being constructed in a tunnel is shown in Figure 7-5. This one is from Central Subway in San Francisco.

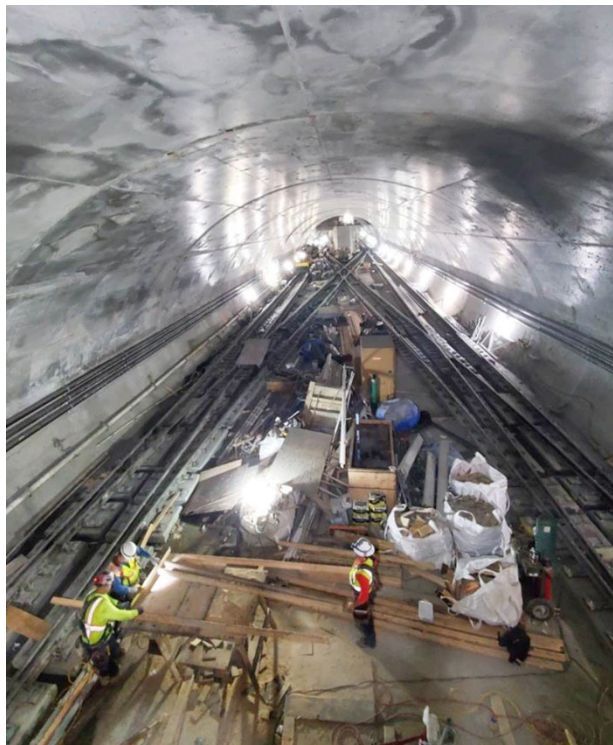

**Figure 7-5. Example of a Track Crossover Section under Construction in Central Subway, San Francisco (SFMTA, 2016)**



### 7.1.4 Portals

At the south end of all alignment alternatives, a new portal is required where the tunnel (or tunnels) will daylight to ground surface and will be constructed either into either rock or soil slopes, except for the Alternative C northbound track, which lacks a bored tunnel. At the north end of all alignments, the TBM will “break-in” through a headwall in a launch box constructed for PAX. A specially designed bulkhead with seals will be placed on the headwall where the TBM will break-in to prevent water and soil flowing around the cutterhead and into the trench.

For the south end of all alignments, a vertical headwall that is part of the portal structure will be constructed by excavating the sloped ground to develop the size, geometry, and orientation for the tunnel to daylight and allow for tracks to be installed at the proper grade at ground surface. At the north end of all alignments, the tunnel portal is assumed to be temporary to facilitate tunnel mining and the final PAX structure will consist of a reinforced concrete box constructed between the portal and the stub tunnel constructed by DTX.

Before any portal excavation is performed, it is typical for support to be installed around the portal to ensure the ground remains intact around the opening. Support types can vary depending on ground type and anticipated behavior but may consist of soil nails, shotcrete, or piles and lagging for deep slope cuts. Dewatering may be required. Rock bolts and shotcrete are typically used when portals are driven into rock.

After the ground has been properly supported and the slope cut back for the desired portal, the TBM can be driven out through the portal headwall, commonly termed the TBM “hole-through” or “break-out.” Portals are typically finished by forming and placing a cast-in-place concrete headwall around the opening as the permanent works. Figure 7-6 shows examples of a single-track portal (left) and a multitrack tunnel (right). Both tunnels were excavated by means other than a TBM but are intended to show the general appearance of portal structures.



**Figure 7-6. Examples of Single and Multitrack Portals**

### 7.1.5 Ventilation and Emergency Egress Shafts

The location and purpose of ventilation and emergency egress structures, hereafter called “the ventilation shafts” for simplicity, are discussed in Section 5.1. These structures are constructed as shafts from the ground surface down. The locations of the ventilation shafts are dependent on finding suitable property to construct it and maintain its permanent presence as a Caltrain-owned facility.

The inverts of the ventilation shafts can be connected to the tunnel, or tunnels, by either a direct connection if it straddles the tunnel, or by a short connecting tunnel called an adit. An adit is necessary where it is not possible for the tunnel alignment to be positioned immediately adjacent to the selected locations and positions of the ventilation shafts.

Ventilation structures constructed in soil will first have a soil support system installed, which if below the water table must be impermeable, such as a slurry diaphragm wall or secant wall. From the invert of the structure, a mined break-in to the tunnel will be constructed where the structure is adjacent to the tunnel. If a connecting adit is necessary between ventilation shaft and tunnel, the adit can be mined from the bottom of the ventilation shaft using the SEM methods described previously. Depending on ground conditions, ground improvement such as jet grouting may be required prior to shaft or adit construction.

Ventilation structures constructed in rock would require an excavated cut and rock support system such as bolting and shotcrete that is installed as the shaft is excavated downward.

The work sequence that follows will involve the installation of permanent structural elements consisting of cast-in-place concrete and steel, followed by mechanical, electrical, and control systems. Finishing architectural work will follow.

### 7.1.6 Building Protection and Ground Instrumentation Monitoring

Considering the depth of excavations, the extent and type of tunneling technique used, the type of ground present, the presence of groundwater, and the proximity of buildings and buried utilities, a comprehensive building protection plan is envisioned. The program will consist of the following major elements:

- Settlement predictions should be made to calculate anticipated ground movement caused by excavations and tunneling.
- Available documentation on the foundations and construction for all existing buildings and utilities within the footprint of anticipated ground movement should be collected and evaluated. Records of existing utility and building construction should be collected and evaluated.
- A Building and Utility Protection Plan should be developed. A typical plan would categorize existing structures by how they must be addressed with the new PAX construction. For example, structures most prone to damage would be identified in a most severe category requiring advance protection measures, a second less severe category might identify measures to be adopted in the event excessive settlement is observed, and a least severe category might not require any advance action.
- A preconstruction survey that includes video and descriptive documentation of existing buildings and utilities prior to the start of construction should be made.

- A geotechnical and structural instrumentation and monitoring program should be developed and implemented for deep cuts, over TBM mined tunnels, near portals and shafts, and over SEM mined excavation. The program would identify the types, locations, and depths of various types of ground monitoring installation across the project. The frequency of readings and reporting structure would be identified. Threshold limits of allowable ground movement would be determined, and the response actions and responsible parties for taking action would be clearly delineated. Actions could include protective measures to the structure, modifying the construction means and methods, or stopping construction altogether until a solution can be determined.
- A settlement mitigation program such as a compensation grout program should be developed. Compensation grout pipes can be installed and pregrouted to precondition the ground between project excavations and structures expected to be affected by construction. These pipes can then be used in tandem with an instrumentation and monitoring program to inject grout at targeted locations to mitigate observed settlement.
- Postconstruction surveys should be made on certain structures after construction for use in comparison against the preconstruction surveys to document if damage might have been caused by construction activities.

These steps would collectively constitute a reasonable and industry-accepted approach to prevent PAX construction work from causing damage to nearby buildings and utilities.

### **7.1.7 Staging Areas and Site Access**

This project is in an urban setting, so the availability of large areas available to stage construction equipment and materials is limited. Potential available staging areas along the project corridor were studied for the purpose of feasibility assessment.

Tunnel excavation operations require a large staging area for the launch pit or shaft; water treatment; power supply; segment storage; a spoils treatment, classification, and storage area; temporary facilities to service equipment and maintain an inventory of spare parts and materials used during construction; and other site facilities such as field offices. Because of the urban setting, limited equipment and materials would be stored at the launch portal. Tunnel lining segments would be stacked to optimize storage space. Tunnel muck is typically preclassified and/or tested in an expedited manner to avoid the operation becoming “muckbound.” Assuming sufficient trucking capacity is maintained to limit the size of the portal-area muck stockpile, and assuming a minimum one-week supply of lining segments will be stored on site to avoid potential delay to the tunneling operation, 2 acres are adequate for staging an EPB TBM mining operation. This is based on stacking twin bore precast concrete segments in units of one complete ring of precast concrete segments. Each ring supports approximately 5 feet of tunnel. The area preliminarily identified to support TBM launch, either from the north or from the south end for the long tunnel alignments, is approximately 2 acres.

## **7.2 Construction Sequence and Constructability Issues for Each Alternative**

This subsection describes the general work sequence for each of the alternative alignments and highlights the major constructability issues. The purpose is to provide the reader with an understanding of the construction workflow that has been assumed to prepare a project cost estimate and schedule, and

demonstrate that based on the facts known or assumed that the alternative is feasible and can be constructed. Significant shortcomings in current knowledge of site conditions or other unknowns that could impact then feasibility of alternatives are identified. Figures of each alignment are included in Section 2.0 (Figure 2-1 to Figure 2-5).

### 7.2.1 Alternative A1

The work sequence assumes a single 42-foot-diameter TBM is launched from the north end of the alignment to mine a single bore, 1.5-mile-long tunnel that will house both northbound and southbound tracks (Figure 2-1). The PAX contractor will assemble the TBM and trailing gear within the DTX-constructed U-wall. A launch from the south end is also possible. The first activity of the PAX tunnel contractor will be to mobilize to a staging area at the north end of the alignment and begin preparatory activities such as bringing power to the site if that has not already been done; and establishing the ability to hoist equipment, materials, and tunnel spoils from grade into the bottom of the U-wall. The design, procurement, fabrication, and delivery of the TBM, which takes 12–18 months (depending on a number of factors including size), would commence immediately upon authorization.

Details of the work a PAX contractor will be required to perform to fully develop the bottom working area of the U-wall trench and TBM launch pit have not yet been fully developed. An example of a TBM prepared for launch through a headwall is shown in Figure 7-7.



**Figure 7-7. Example of a TBM Set Up and Ready to Excavate into a Headwall (46-foot-diameter TBM, Waterview, NZ)**

Coordination with the DTX/PAX interface was conducted to optimize the interface on a preliminary basis. Existing Caltrain tracks at the surface are within the footprint of the proposed U-wall box and TBM launch area, as are the proposed DTX tracks. As currently proposed, this interface includes a four-track configuration south of Fourth and Townsend Street that would accommodate PAX construction concurrently with revenue service in a completed DTX system. This interface concept is shown in Figure 7-8 and will enable a PAX TBM launch box for launching a TBM southward or receiving a northbound TBM, to be constructed adjacent to rather than underneath in-service rail lines. The stub track to the

railyard shown in in Figure 7-8 is illustrative only and is intended to show that it is feasible for PAX to connect to a subsurface railyard.

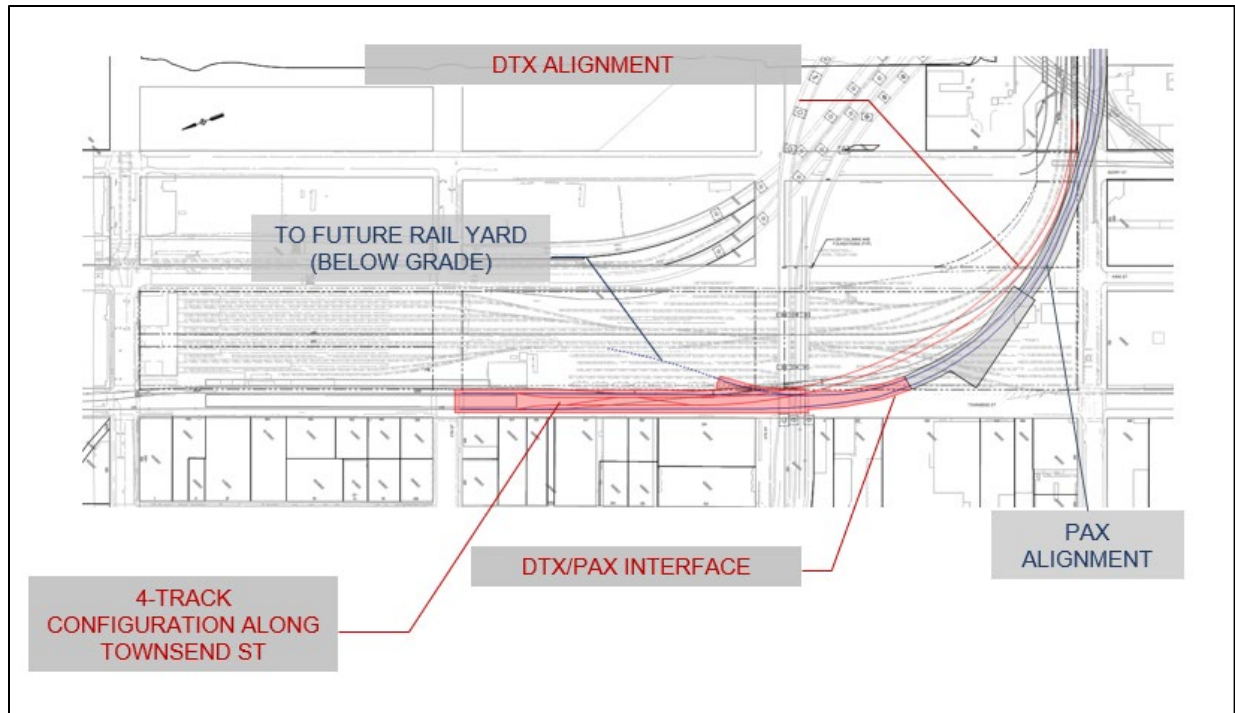

**Figure 7-8. PAX TBM Launch Chamber near Interface with DTX (gray area), Showing Interference with Existing Caltrain Tracks (blue)**

The TBM launch headwall will be prepared as described in Section 7.1.4 to allow the TBM to penetrate, or break-in through the headwall and begin mining down 7th Street through the improved ground. Precast concrete segments will be continuously installed behind the TBM for the entire tunnel length beginning at the headwall, as described in Section 7.1.1. The TBM will continue down 7th Street and make the turn to the right to excavate south underneath Pennsylvania Avenue. The tunnel will slope downward at 2% to pass beneath existing large utilities, gain ground cover over the tunnel, and pass through more favorable geologic units for tunneling.

The TBM will pass under the SFPUC's Division Street sewer, a four-compartment concrete box sewer on piles, and beneath the future planned SFPUC Folsom Sewer Tunnel. These utilities are shown in the red stippled areas in Figure 7-9. This area will need to be further investigated in detail to be sure there is adequate clearance between the top of the tunnel and the bottom of the existing piles, to ascertain whether preinstalled ground improvement is required, and to develop a program to instrument and monitor ground and utility movement during excavation to ensure the integrity of this structure.

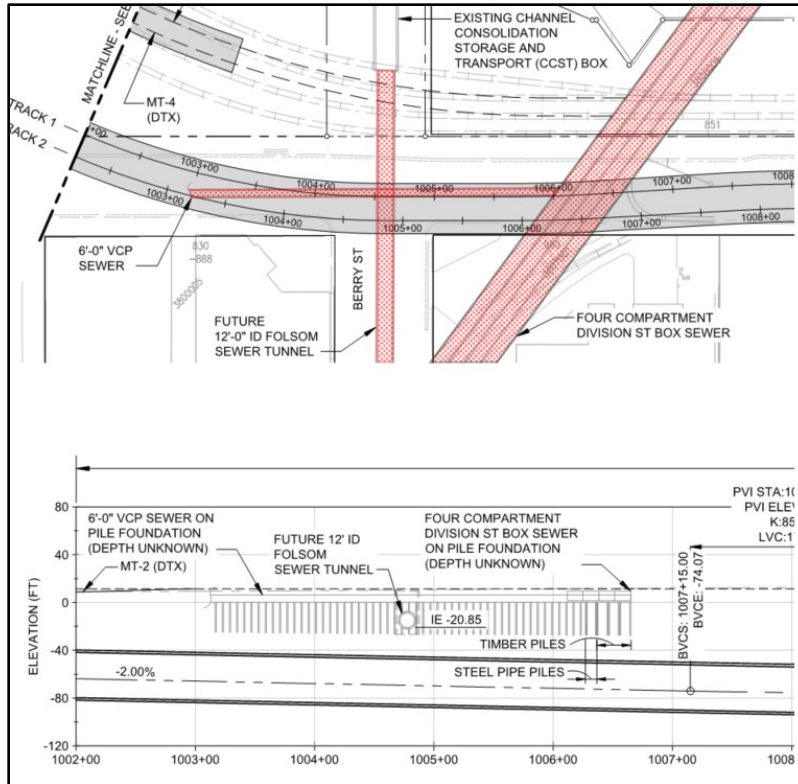

**Figure 7-9. Area Where PAX Alignment (gray) Crosses Existing Division Street Box Sewer (red) and Future Folsom Street Sewer (red)**

The tunnel will be excavated through a mix of soil and weak rock. The most difficult formation to excavate through in terms of risk of ground loss, ground settlement, or an uncontrolled blowout to the surface is the Young Bay Mud (YBM). Starting from the launch pit, the tunnel vertical profile is kept below this formation, yet it persists just above the tunnel crown where it still poses a risk. Further studies will be required to predict the extent of YBM more scientifically along the alignment and to develop measures that will be required to ensure TBM mining does not cause ground settlements in this weak formation. Figure 7-10 depicts the occurrence of the YBM relative to the tunnel at the north end of the alignment.

Rock is anticipated to be encountered at approximately Station 1019 (Hubbell Street), with either a mixed face of soil and rock or a full face of rock persisting to Station 1032 (17th Street), as shown in Figure 7-11. Thereafter and southward to the tunnel termination the tunnel is expected to be in rock.

From its low point at elevation -95 feet near Station 1026 (16th Street), the tunnel climbs southward to its terminus, first at a 1% grade then steepening to 2%.

Another area of note is from Station 1059 to Station 1073, beneath Pennsylvania Avenue. The ground cover over the tunnel decreases to about one tunnel diameter or less in this stretch. Further, there are areas of soil or fill above the top of rock contact, which is located at an uncertain depth. This is shown in Figure 7-12. Further exploration will be required to determine what, if any, special measures may be required in this area such as ground improvement in advance of tunnel excavation.

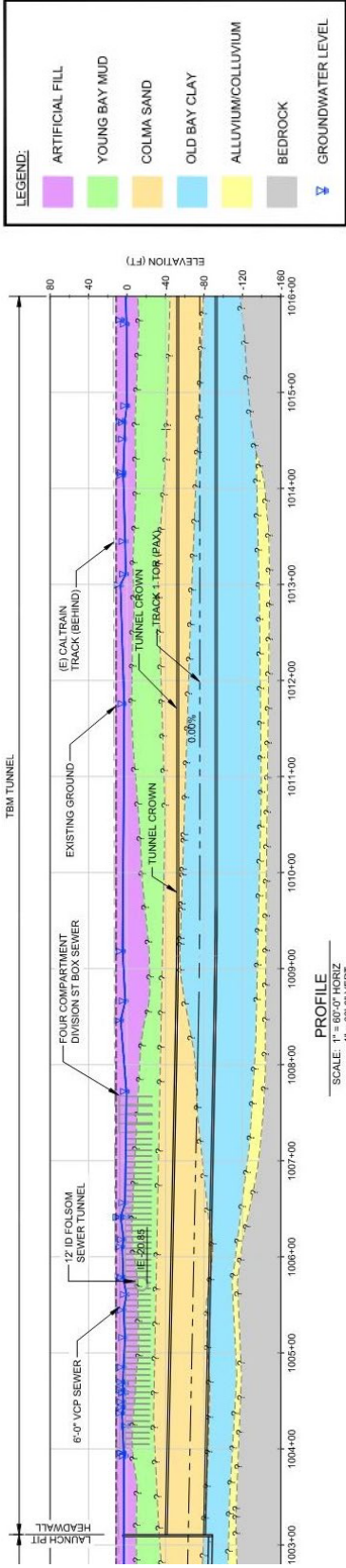

Figure 7-10. Geologic Profile Showing Soil Units Relative to PAX Profile at North End of Tunnel (refer to legend, right)

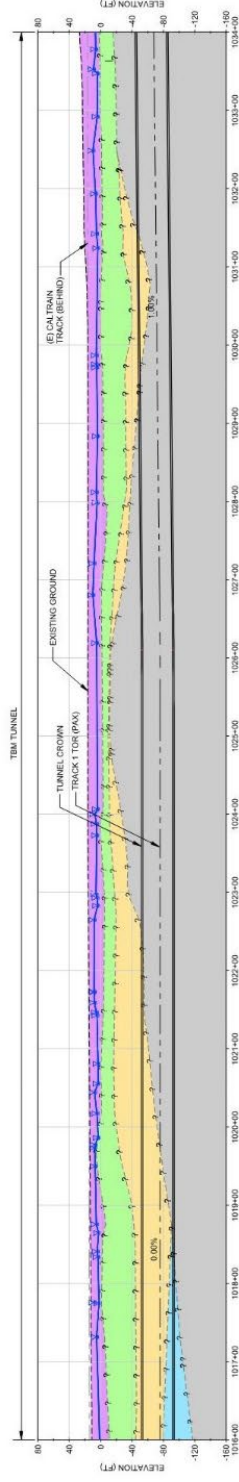

Figure 7-11. Area of PAX Alignment Where Mixed Soil/Rock Conditions are Anticipated to Occur (refer to legend, above)

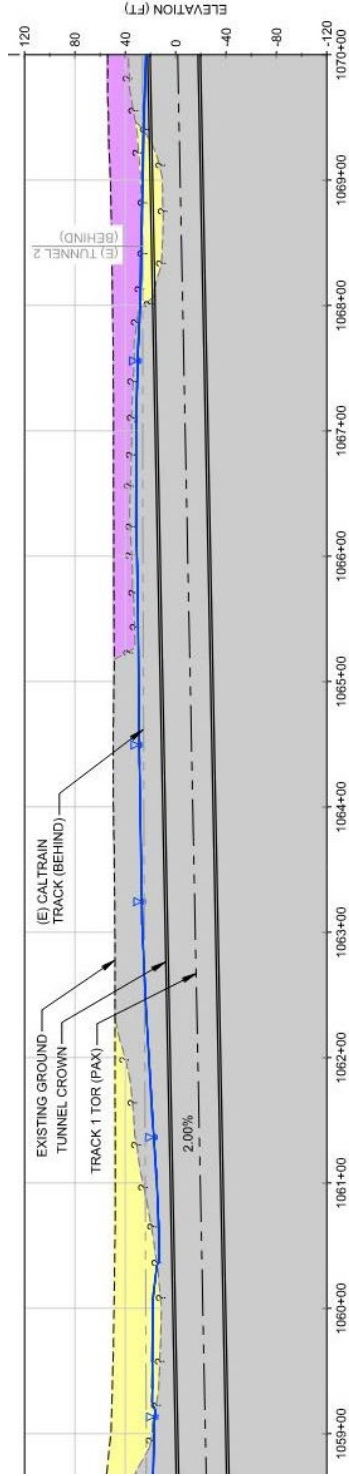
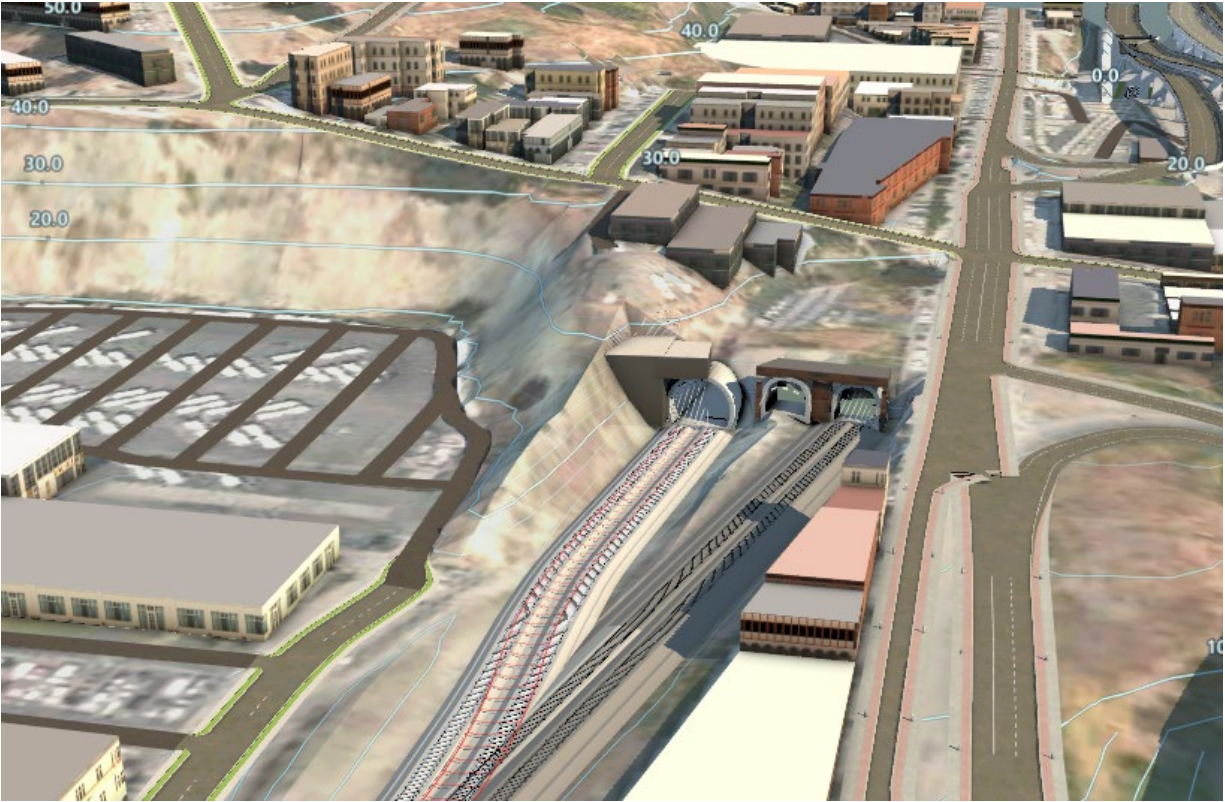

Figure 7-12. Area of PAX Alignment with Low Ground Cover (refer to legend, above)

The southern breakout area in the portal at Station 1079+00 will be prepared by installing a retaining wall and headwall next to the existing tunnel portal. The TBM will break-out through this headwall to complete the tunnel drive. A conceptual sketch of where the portal and ventilation structure will be located on an oblique view 3D rendering is shown in Figure 7-13. The area in the Caltrain ROW from Stations 1079 to 1084 will be graded and leveled to prepare for track installation and a tie-in to the existing Caltrain tracks.



**Figure 7-13. South Portal Area for the Alternative A1 Alignment, Showing Potential New Portal Area, Conceptual Footprint of a Ventilation Structure, and Track Tie-in to Existing Caltrain Rail**

Four ventilation shafts/structures are proposed for Alternative A1, as shown in Section 5.1. They are located at Stations 1000, 1025, 1043, and 1078 at the south portal. The structure at Station 1043 will likely require a connecting adit. The construction considerations for these structures are described in Section 7.1.5.

Two 600-foot-long track crossovers are proposed, one from Stations 1014 to 1020 and the other from Stations 1038 to 1044. As discussed in Section 7.1.3, the trackwork for the crossovers will be constructed within the confines of the lined single bore tunnel.

The tunnel will be completed with a deck slab constructed of precast concrete or cast-in-place concrete that will provide a platform for trackwork. A divider wall may be installed between the two tracks depending on the ventilation and fire/life safety (FLS) design. The cost estimate assumes a divider wall at all locations except the crossovers. A drainage, sump, and pumping system to handle any water infiltration will be installed. Control, electrical, and mechanical systems will complete the works in the tunnel. Figure 7-14 depicts an assumed cross section of the single bore tunnel.



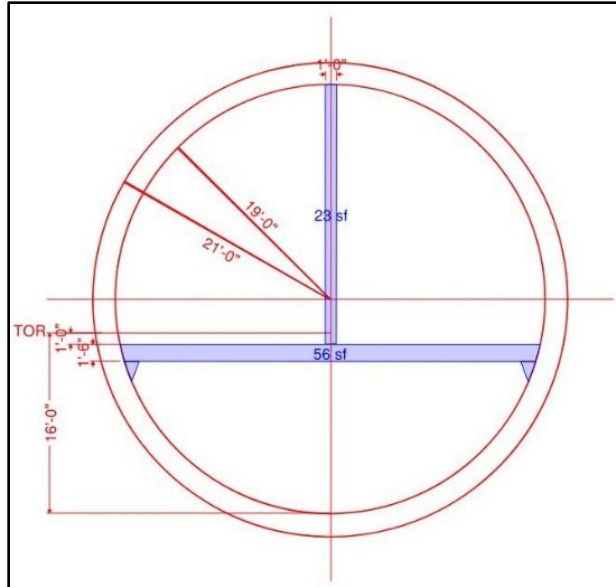

**Figure 7-14. Simplified Cross Section of a Single Bore Tunnel Showing Dimensions Assumed for Cost Estimating in this Study**

Alternative A1 cannot make use of the existing 22nd Street Station. Station alternatives within the PAX project limits include a new underground station in Pennsylvania Avenue between 22nd Street and 23rd Street. Traditional methods for station construction are to construct a cut-and-cover structure for the length of the station. The soil support system can be constructed and decked over to allow limited traffic flow and shafts to access the station work area below. An alternative is to construct the station platforms within the lined TBM tunnel, which may reduce the footprint of headhouse shafts that provide access to platform level. This alternative may require a larger diameter bore to accommodate platform and access sizing. Further study or discussion of station options is outside the scope of this study.

### 7.2.2 Alternative A2

The work sequence assumes two 26-foot OD TBMs are used to excavate the 1.5-mile-long twin tunnels that will have one track each as shown in Figure 2-2. The TBMs will be launched from the north end of the alignment by assembling the TBMs and trailing gear within the DTX constructed U-wall. A different configuration of the headwall is required for two TBMs than for the single bore as shown in Figure 7-14. A launch from the south end is also possible. This option will require the same 2-acre work area for servicing the tunnel excavation. Of note, it is less expensive to conduct work from a portal than to conduct work from a launch box because a significant amount of construction-related hoisting is avoided. The savings would be on the order of 5–10% of the cost for tunnel excavation.

Early activities of the PAX tunnel contractor after mobilization at a staging area are similar to those described for the single bore in Section 7.2.1. The discussion in that section on the coordination required for the U-wall and launch pit in terms of the split of work between DTX and PAX is also applicable to Alternative A2.

As with Alternative A1, existing Caltrain tracks at the surface and the future subsurface DTX tracks are within the footprint of the proposed U-wall box and TBM launch area. A solution similar to that shown in Figure 7-8 will be needed to allow Caltrain operations to proceed during construction of PAX.

It is generally preferred to have a one-tunnel diameter separation between two adjacent tunnels. In the northern section of Alignment A2 this is not possible in all locations because of the narrow width of public right-of-way between the existing I-280 deep foundations on the east side of 7th Street and the private property boundary on the west side. This is clearly shown in Figure 7-15, where the distance between tunnels is indicated to be less than 5 feet.

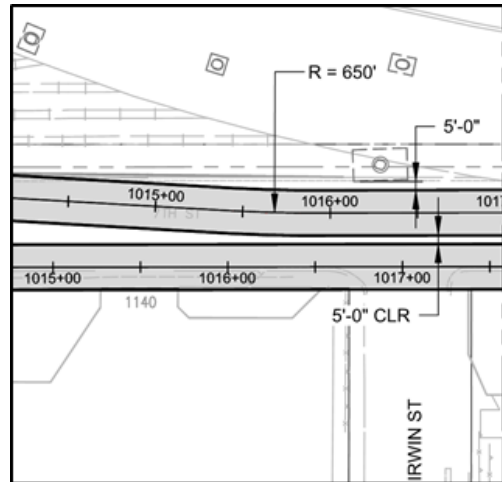

**Figure 7-15. Area on 7th Street Where the Two Twin Bore Tunnels are Indicated to be within 5 Feet of Each Other**

To assess the feasibility of placing two TBM mined tunnels this close together, an evaluation was performed as part of this study on the “pillar width,” or separation distance between the two tunnels as measured at tunnel springline. This evaluation is based on two-dimensional numerical analyses using finite difference software FLAC (Itasca, 2016). A critical cross section at Station 1015+00 was selected for the analyses and represents the anticipated worst-case condition over the tunnel reach with respect to ground conditions and where the narrowest pillar will be formed. Ground cover above the tunnel crown is approximately 60 feet.

The evaluation focused on the following design considerations: (1) ground movement and surface settlement; (2) segmental lining performance in terms of deformation and structural demands compared to capacity; and (3) stresses and strains in the pillar. Four different pillar widths were evaluated: 5, 13, 20, and 26 feet. The results indicate that ground movement and surface settlement will not be significantly affected by the changes of pillar width, though generally the deformations increase as the pillar width decreases. Similarly, displacements and structural demands of segmental linings for both tunnels appear not to be affected significantly by the changes of pillar width. However, the stability and behavior of the ground that forms the pillar between the two parallel tunnels is predicted to be affected significantly by pillar width, especially when the pillar is narrowed to less than one times the tunnel diameter. The evaluation showed that a minimum pillar width of 13 feet is judged as acceptable where the soil making up the pillar is not improved. Ground improvement to enhance strength and stiffness of soil within the zone of the pillar will be required to further reduce the pillar width down to 5 feet or less.

As a result of the evaluation, cost estimates for this alternative assume significant ground improvement will be required along 1,300 feet of the tunnel alignment. This ground improvement can be accomplished using several methods, but a likely choice will be jet grouting. Jet grouting involves the use of drill rigs working from the surface that inject, or “jet,” a cement and water mix into the soil from a rotating steel drill at very high pressures to mix and strengthen the soil and create a column of grouted soil. Jet grouted soil columns are overlapped and would cover a zone about 26 feet wide and 40 feet deep and centered between the two tunnels. This will provide an improved soil mass to tunnel through that reduces risk of ground loss and settlement. This process will also create a grouted soil mass between the tunnels to serve as “grout pillars” to stabilize the ground.

Figure 7-16 is a photo from LA Metro’s Purple Line Extension in Los Angeles showing an example of jet grouting at the surface. As can be seen, in this case the grouting work is performed on the right side, with vehicle travel lanes established on the left side. The PAX grouting will require various degrees of street closures depending on how the work is staged and the designated work hour restrictions. At least half of the jet grouting work will need to be performed using low-headroom equipment because of the I-280 viaduct over the east half of the improvement area.

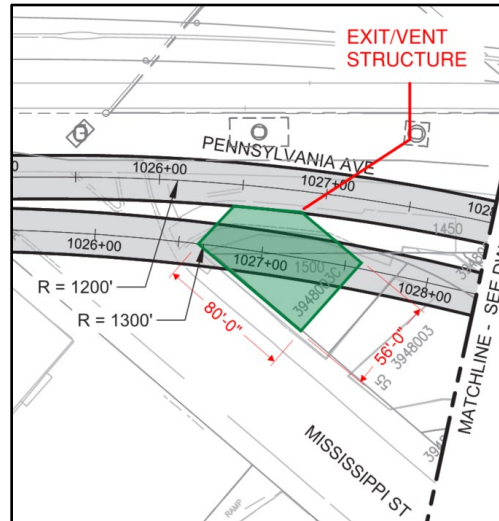

**Figure 7-16. Example of Footprint Required for Jet Grout Operations from Surface and Associated Traffic Control (LA Metro Purple Line)**

As with Alternative A1, A2 will be excavated through a mix of soil and weak rock. The primary difference is that the invert of the A2 alignment bottoms at elevation -80 feet, 15 feet shallower than Alternative A1, and there is always at least one tunnel diameter of ground cover over both tunnels except for the first 400 feet at the northern end of the alignment. The vertical grades for Alternative A2 are similar to those for Alternative A1.

The southern break-out area for the two tunnels will be at a portal area that will be similar to that described for Alternative A1, with the exception that two TBMs will break-out here with an approximate 20-foot separation distance. This will result in a wider twin portal/headwall structure than that for Alternative A1, with the new northbound tunnel being situated 10 feet or less from the existing abandoned Caltrain Tunnel 2.

Four ventilation shafts/structures are proposed for Alternative A2, as shown in Section 5.1. They are located at Stations 1002, 1027, 1044, and 1078 at the south portal. The southbound tunnel runs through the middle of the footprint of the ventilation shaft at Station 1027 (Mississippi Street), which straddles the northbound track. This is shown in Figure 7-17 (the vent shaft location is approximated for illustration purposes only). The structure can either be built prior to TBM excavation with the TBM being “walked through” the ventilation structure opening, or be constructed following the TBM passing through this area. The ventilation shaft at Station 1044 will require a 73-foot-long connecting adit, and the shaft is shown as being constructed in 19th Street. The construction considerations for these structures are described in Section 7.1.5.

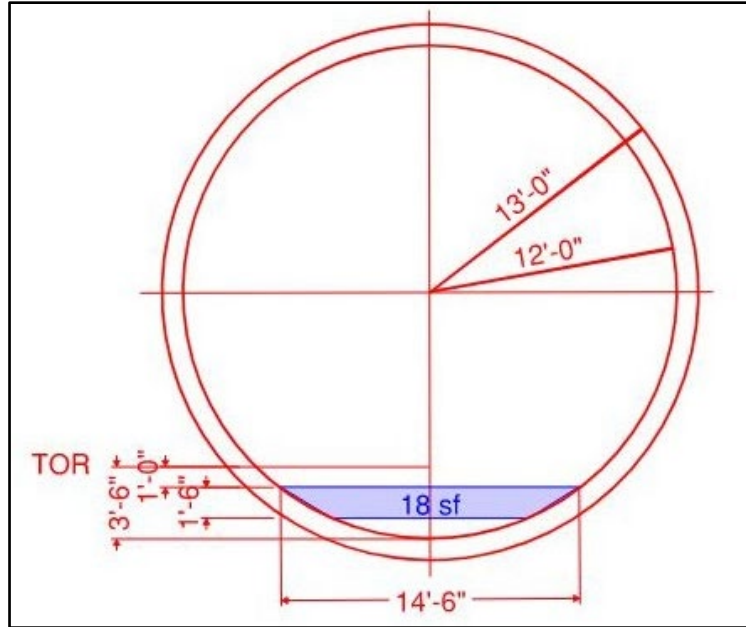

**Figure 7-17. One of the Proposed Exit/Vent Shaft Locations for Alternative A2**

A single 300-foot-long track crossover is proposed from Stations 1039 to 1042. As discussed in Section 7.1.3, the trackwork for the crossovers will require SEM mining between the two tunnels to create an open space for the entire length of the crossover where the track layout can be installed.

A total of five cross-passage connections are estimated to be required along Alignment A2. One of them will be provided at the ventilation shaft structure at Station 1027, which has a footprint filling the separation area between the two bores. The other four will require SEM mining, as described in Section 7.1.3.

The tunnel will be completed with a bottom slab that may be constructed of precast concrete or cast-in-place concrete that will provide a platform for ties and trackwork to be installed. A drainage, sump, and pumping system to handle any water infiltration will be installed. Control, electrical, and mechanical systems will complete the works in the tunnel. Figure 7-18 depicts an assumed cross section of one of the twin bore tunnels.



**Figure 7-18. Simplified Cross Section of a Tunnel for the Twin Bore Option (Alternative A2) Showing Dimensions Assumed for Cost Estimating in this Study**

### 7.2.3 Alternative B1

This alternative envisions a single bore TBM tunnel terminating at Station 1048 between 19th and 20th Streets. From this point the tunnel bifurcates into two SEM mined tunnels that curve in horizontally to connect to the existing Caltrain line (Figure 2-3). The description of construction issues between the DTX headwall and Station 1048 is essentially the same as previously described for Alternative A1 in Section 7.2.1, and is not repeated in this section. It is noteworthy, however, that there is less than one tunnel diameter of ground cover for the first 400 feet at the northern end of the alignment, as well as between Station 1020 and Station 1038 under 7th Street and Pennsylvania Avenue. Ground improvement may be required in this zone. As depicted in Figure 7-19 below, this section focuses on the construction issues from the TBM termination point at its southerly end (red in the figure), the SEM mining (blue), and the connection of the new northbound track into the existing Caltrain live tunnel that contains the existing northbound track (green).

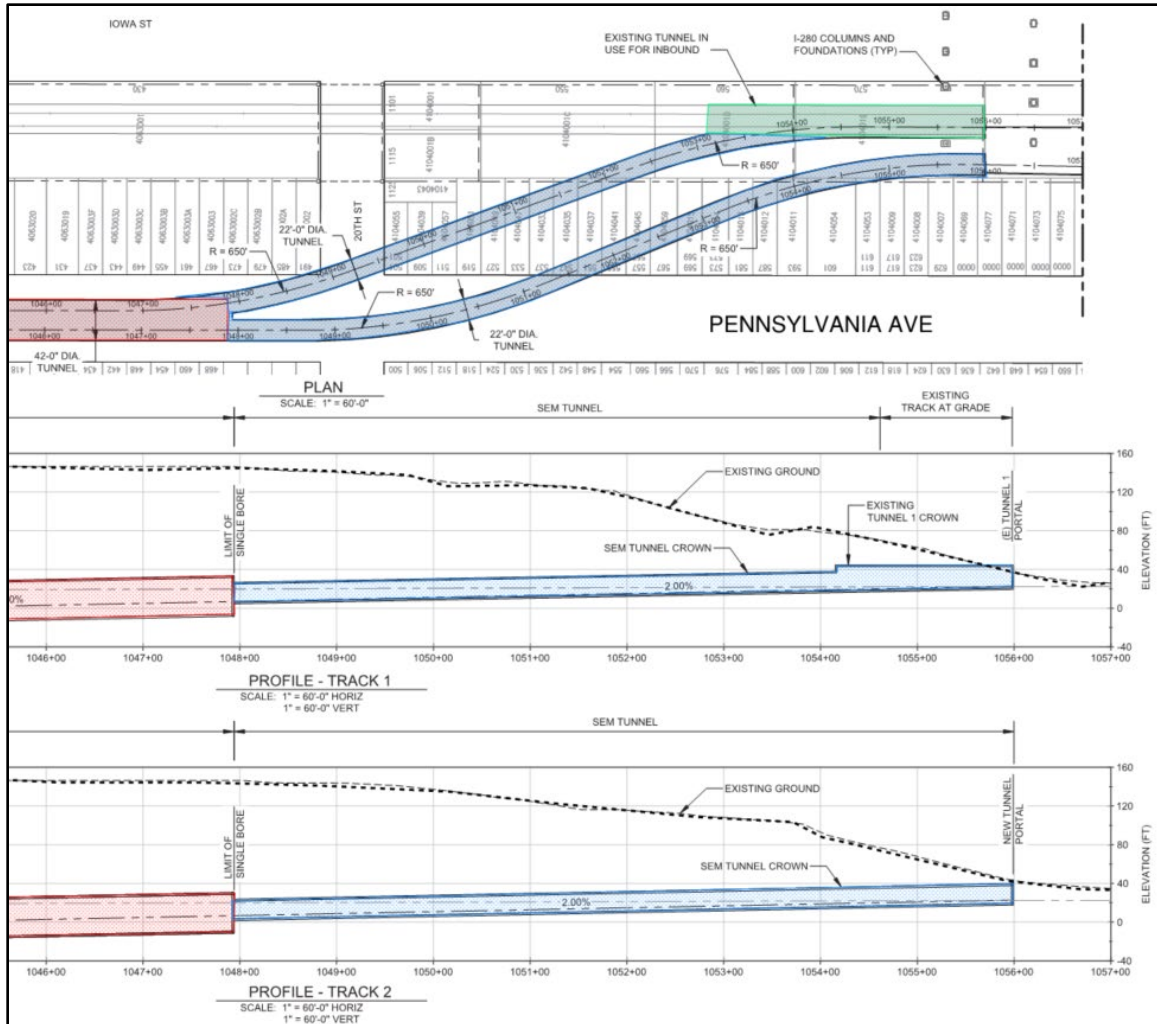
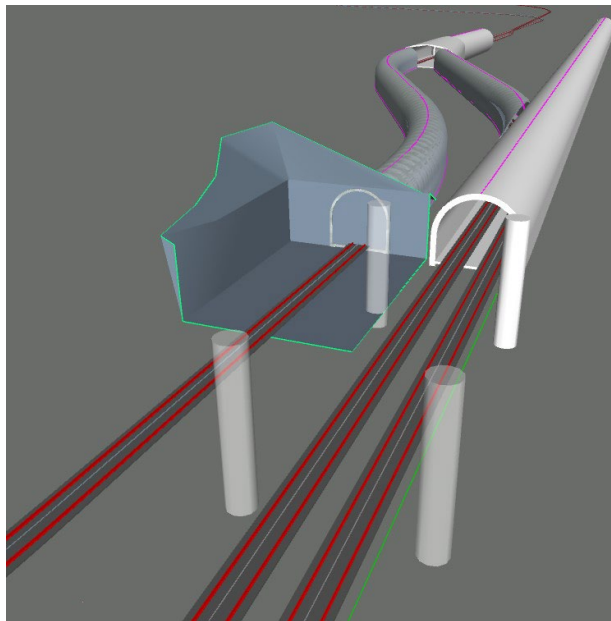

**Figure 7-19. Plan and Profile of the SEM-mined Connections from the South End of a Single Bore Tunnel to existing Caltrain Tracks for Alternative B1**

Starting from the end of TBM mining, the work sequence to complete the branch tunnels by SEM methods to connect to the existing Caltrain tracks will be as follows (a 3D rendering of the two SEM tunnels is shown in Figure 7-20):

1. The TBM will be stripped of all mechanical, electrical, and structural equipment within the TBM shield and removed from the tunnel. The TBM cutterhead will either have to be collapsible, or will be cut into pieces and removed after the ground in front of the TBM, assumed to be weak rock, is improved and stabilized.
2. Break-out areas will be prepared ahead of time at the existing Caltrain side. This work will be adjacent to live rail, so work will have to be conducted at nights and on weekends to avoid service disruption. Work space here is very limited. For the northbound tunnel, the connection is a break-out to the existing Caltrain Tunnel No. 1 north of 22nd Street Station. The break-out area will be prepared by presupporting the intersection of the two tunnels with spiling and rock bolts. An SEM alcove may be excavated from the existing tunnel side to push the TBM break-in area further away from live rail operations.

3. For the southbound track, a headwall (retaining wall) will be constructed adjacent and just west of the existing Tunnel No. 1 south portal. A new portal for the southbound track will be prepared with spiling and rock bolting. A short distance of tunnel may be driven to create a receiving chamber for the SEM-mined southbound tunnel.
4. Two SEM tunnels will be driven from the TBM tunnel toward the existing Caltrain tunnel (green area in Figure 7-19). At this time, it is understood that there is not likely to be a sufficiently sized staging area between 20th Street and 23rd Street, along the Caltrain ROW, to support SEM operations from south to north (toward the TBM tunnel). For the northbound track, the logistics of mining the SEM tunnel from the active Caltrain Tunnel to the TBM tunnel under live track conditions have significant cost and schedule implications. For these reasons, the assumption is that both SEM tunnels will be driven from the TBM bored tunnel, supported from the work staging area at the north end of PAX.
5. The SEM mining will proceed as described in Section 7.1.1.2. Both tunnels are believed to be entirely in weak rock, based on the desktop study performed. However, both tunnels have minimal rock cover and further explorations will be required to fully characterize the ground along these two alignments. For the purposes of this study, the SEM tunnels were considered to require a pipe canopy presupport system installed in advance of tunnel excavation.
6. The two SEM tunnels will break out through the previously described portals at the existing Caltrain side.
7. A final lining system consisting of cast-in place concrete will be installed. It will be placed inside the TBM shield to join up with the precast segments in the TBM mined tunnel. A waterproof system will be required behind the final lining and inside the initial ground support.
8. The final stage will be installation of track and systems and a tie-in to the existing Caltrain system. See Figure 7-20 for a visualization of this.



**Figure 7-20. 3D Rendering of the Tunnel Connections from TBM Bored Tunnel (upper left) to Existing Caltrain Tracks/Tunnel (right)**

South of the tunnel portals and connection to the existing Caltrain track, there will be work required at 22nd Street Station. A new southbound track will be installed at-grade from the new southbound tunnel portal, through the 22nd Street Station area, and through a rehabilitated existing Tunnel 2 that has been abandoned for a number of years. This will require construction of a new retaining wall along the property boundary on the west edge of the station to create the at-grade space necessary to run the new southbound track outboard (west) of the existing I-280 piles. The new northbound track will be rerouted to the existing southbound track and pass through 22nd Street Station and the live Caltrain tunnel (Tunnel No. 2). This concept is shown in Figure 7-21. The new retaining wall is shown in blue, the new southbound track is orange, and the northbound track is green. Conversion of the 22nd Street station platform and access to a center platform layout will be required to accommodate the new alignments, costs for which are included in the study cost estimate.

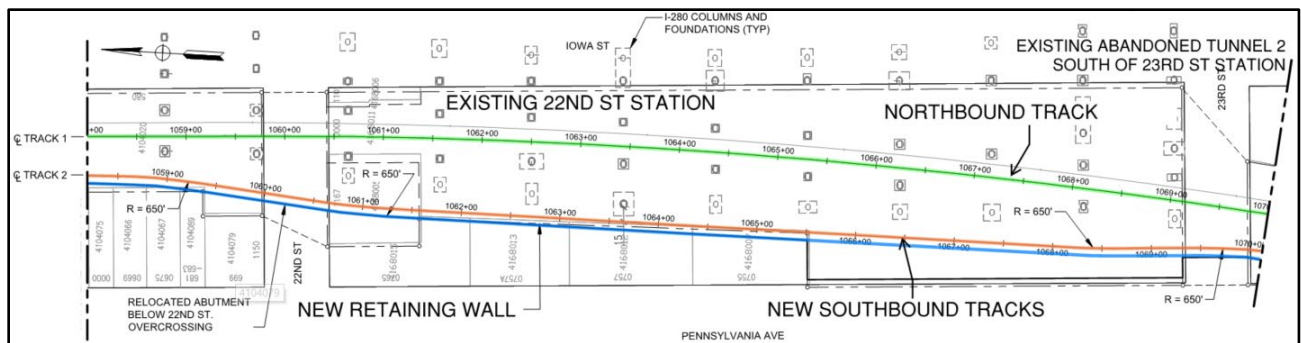

**Figure 7-21. Improvements Necessary at 22nd Street Station for Alternatives B1 and B2**

The condition of Abandoned Tunnel 2 is uncertain. For the purposes of this study and preparing a cost estimate, it was assumed that the scope of upgrade previously performed on the live Caltrain tunnels would suffice for Abandoned Tunnel 2 (south of 23rd Street). Generally, this work included the application of shotcrete (sprayed concrete) lining over the existing brick linings and a seismic upgrade. The seismic upgrades would include contact grouting, installation of shotcrete, installation of rock anchors, restoration of missing drainage gutters and installation of sump pumps.

South of the Abandoned Tunnel 2 portal and north of Cesar Chavez, the new southbound track will be tied into the existing southbound track at the existing grade.

North of the SEM tie-in to the existing Caltrain tracks, the number and locations of cross passages, ventilations shafts, and track crossovers are the same as Alternative A1.

## 7.2.4 Alternative B2

A twin bore variant of Alternative B1 was developed that envisions excavating with two TBMs the entire way into the existing Caltrain ROW north of the 22nd Street Station (Figure 2-4). This will eliminate most of the SEM mining required from the termination point of TBM mining (Station 1048) in Alternative B1. This concept is shown in Figure 7-22, with the twin TBM drives shown in red, a SEM mined receiving alcove on the northbound line in blue, and the existing live Caltrain Tunnel No. 1 in green.



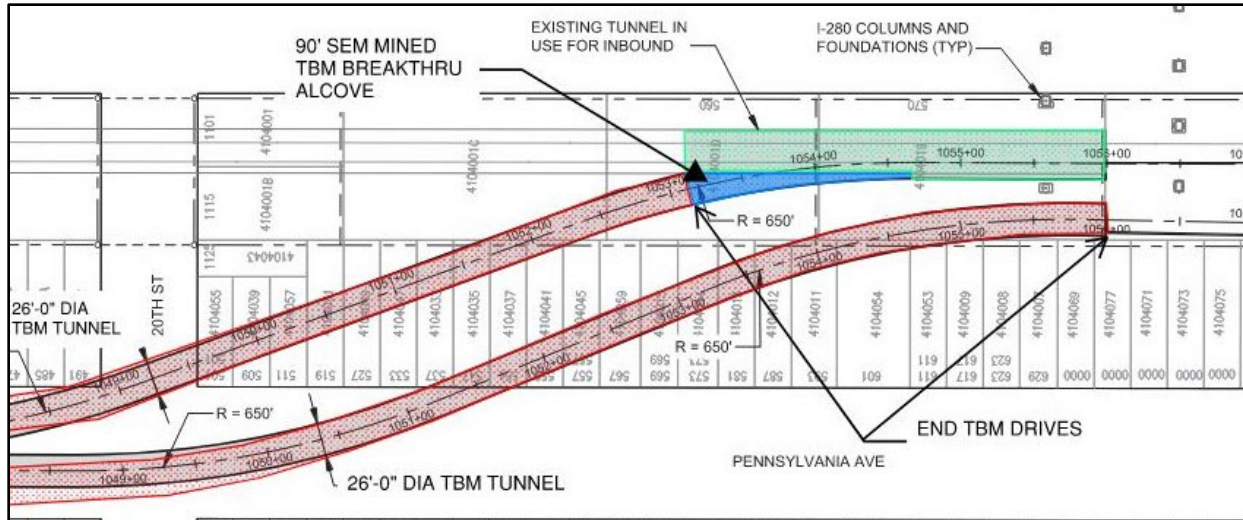

**Figure 7-22. Plan and Profile of the Twin TBM Bored Tunnel Connections to Existing Caltrain Tracks for Alternative B2**

Considering the limited working area in the Caltrain ROW, active passenger rail operations in Tunnel No. 1 and poor access, construction logistics will be challenging to remove the two TBMs while minimizing disruption to active rail service. The TBMs could be disassembled and removed at the north end, from where they were launched.

All other construction considerations north of 20th Street are as described for Alternative A2, the twin bore concept. All other construction considerations south of the twin bore connection to the existing Caltrain line are as described for Alternative B1, including 22nd Street Station modifications, a new retaining wall between 22nd Street and 23rd Street, and the rehabilitation of Abandoned Tunnel 2.

### 7.2.5 Alternative C

Alternative C includes a cut-and-cover tunnel and U-wall at the north end of the project that snakes from the DTX boundary through the existing I-280 piles, tying into the existing Caltrain northbound tracks on the north side of the existing Caltrain Tunnel #1 portal between Mariposa Street and 16th Street. The southbound tracks would be installed in a 26-foot-diameter TBM bored tunnel aligned along 7th Street and then Pennsylvania Avenue, which then connects to the existing southbound Caltrain track at a portal just north of the 22nd Street Station. The TBM bored tunnel is essentially the same southbound alignment as Alternative B2 (Figure 2-5).

This alternative solves the problem of the space restriction for two 26-foot-diameter bored tunnels in 7th Street that is described for Alternative A2, while making use of the existing 22nd Street Station. The construction considerations of the TBM bored tunnel are the same as those for the southbound tunnel in Alternative B2, with the exception that the concerns associated with the close separation between two tunnels under 7th Street are eliminated. The discussion of this alternative will therefore focus on the northbound track cut-and-cover tunnel/U-wall section. The general methodology for construction of the cut-and-cover tunnel is as previously described. The groundwater table cannot be lowered during construction using dewatering, so the cut-and-cover construction must prevent water inflows into the

excavation. In addition to an impermeable slurry wall or secant pile wall system, the invert of the excavation must be jet grouted.

Beginning at the DTX U-wall trench, the cut-and-cover tunnel alignment has potentially more severe conflicts with the existing Caltrain tracks that head south from the railyard. This conflict on other alternatives is limited to the U-wall area as all tunnels are bored beneath the tracks. The cut-and-cover tunnel through this area will require temporary shutdown and relocation until decked over and the tracks can be restored.

Figure 7-23 shows the constraints described in this paragraph. The cut-and-cover tunnel will impact surface tracks that will access the railyards once the DTX alignment is operational and will require a shutdown of Berry Street, shown in green. Alternate access is available via King Street. The tunnel will cross SFPUC's Consolidated Transport/Storage Box Sewer (brown), a large concrete structure below grade in Berry Street that conflicts with the proposed alignment. The tunnel also conflicts with the four-compartment Division Street Box Sewer (brown; crossing the PAX alignment at an angle). Neither of these structures can be relocated. The new DTX U-wall will require a special design to excavate and build the PAX tunnel under these structures so that the tracks can be installed at the desired elevation. The design will need to be sufficiently robust to avoid settlement and damage to the existing structures. Complicating matters is the presence of fill and Young Bay Mud in this area, both of which can exacerbate ground settlement if not adequately addressed. A little further south along the alignment at Station 1012, an existing column support for I-280 stands directly in the proposed alignment (yellow) and will require relocation. Rerouting the rail alignment around the column is not feasible.

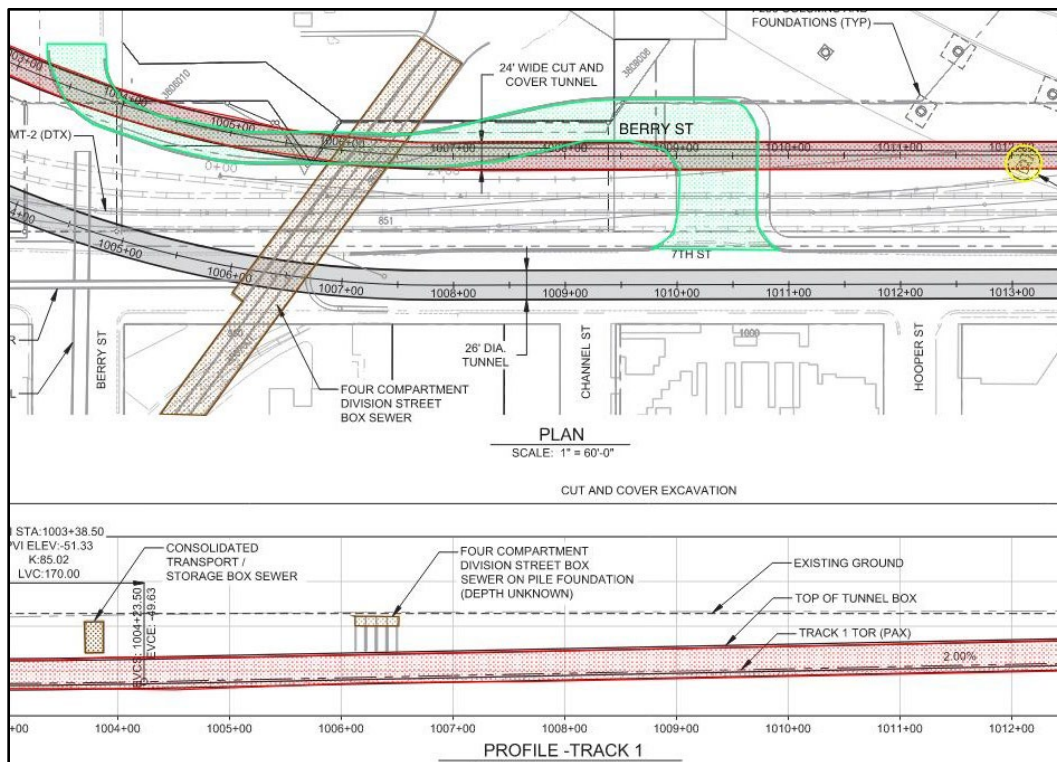

**Figure 7-23. Interference Issues Pertaining to the Cut-and-Cover Section for Alternative C PAX Alignment (red). Division Street Box Sewer (brown), Berry Street (green), and Relocation of Existing I-280 column (yellow).**

The cut-and-cover trench will be as deep as 70 feet below ground surface with the ground supported by slurry walls. The tunnel climbs at a 2% grade to Station 1026, where it daylights and transitions to a U-wall trench that can be constructed with secant piles or slurry wall. Between 16th Street and Mariposa Street (Stations 1030 to 1035), there are at least three I-280 columns that will require relocation, as shown in yellow in Figure 7-24. Details of column relocation, including additional column relocation that could facilitate simplified cut-and-cover structures, can be studied during future phases. The new northbound track reaches the existing grade at Station 1037 just north of the existing Caltrain tunnel (blue), where new track is tied into existing. The Caltrain tracks must be removed first to install the U-wall, and there is no room to construct a shoofly to maintain service. Technical details for this option will need to be refined in future studies.

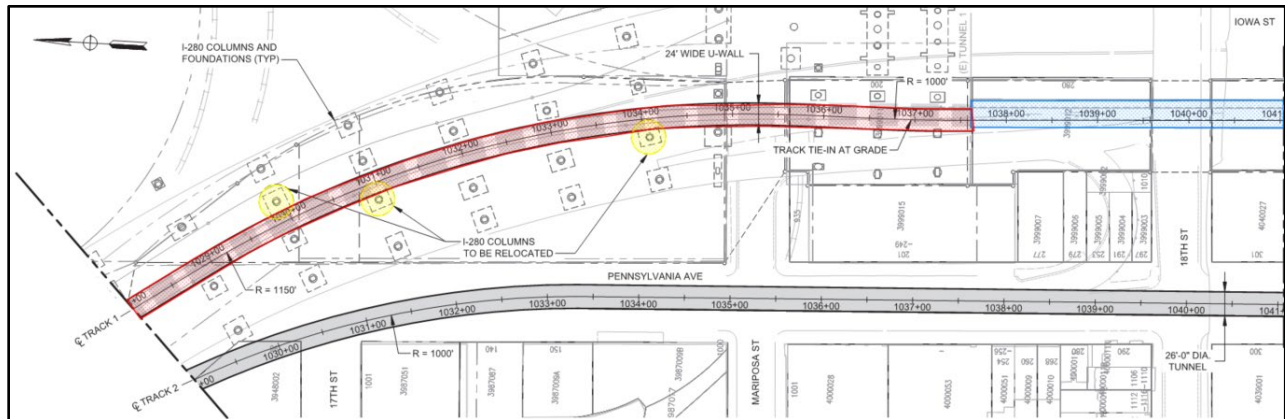

**Figure 7-24. Interference and Connection Details in the 17th Street and Mariposa Street Area of Alternative C. New Cut-and-Cover Tunnel (red), TBM Bored Tunnel (gray), Relocated I-280 Columns (yellow), and Existing Caltrain Tunnel No. 1.**

Cut-and-cover construction will also impact the two at-grade intersections during construction, requiring full or sequenced partial street closures to complete the cut-and-cover tunnel across the intersections. Excavation methods that would enable an undercrossing should be investigated during the next phase of work to minimize disruption to surface traffic.

## 8.0 Existing Utilities

### 8.1 Methodology

As part of the evaluation of existing conditions along the different alignment alternatives, major utilities were identified in order to assess the potential impacts to construction and operations of the PAX project. The evaluation of existing utilities and potential conflicts will allow for identification and resolution of these issues in the following phases of design and development of alternatives.

A desktop study was completed for locating the utilities along the PAX corridor. No field investigations were performed for this phase of the project. They will be conducted in the preliminary engineering/environmental phase of the project. The locations of existing utilities were determined by reviewing several resources. Utility mapping was requested from the following utility owners: San Francisco Public Works (SFPW), San Francisco Public Utilities Commission (SFPUC), San Francisco Department of Technology (DT), PG&E, AT&T, Comcast, and Peninsula Corridor Joint Powers Board (PCJPB). PG&E provided maps for gas and electric distribution and transmission lines. SFPUC and SFPW provided combined sewer, separated storm drain, and separated sanitary sewer system maps including as-builts and record drawings for adjacent projects. The sewer depths were provided by SFPW in record drawings, and general assumptions were made for depths of all other utilities that could not be confirmed by record drawings. Verification of assumed depths will also be conducted in the preliminary engineering/environmental phase. SFPW also provided potable and high-pressure water system maps. AT&T, Comcast, and DT provided communication line maps for fiber optic and copper wire infrastructure for aerial and underground facilities.

The existing utility mapping was overlaid with topographic information collected from third-party sources. Field visits and Google street views were utilized to reconcile mapping from the third-party sources. By overlaying this information in both plan and profile with the proposed alignment alternatives, possible locations of utility conflicts and relocations were determined. No topographic surveys were performed as part of this scope of work. Topographic survey to document all existing conditions, not only utilities, should be performed as the first task of the next phase of this project.

The identified utility map and conflicts along the proposed alignments are presented in Appendix F.

### 8.2 Findings

The utility desktop study identified various utilities along the alignments that will need to be verified and investigated in future phases of the project to determine if there are any conflicts with the proposed project corridor. The following utility locations, sizes, and depth will need to be verified:

- **6th and Townsend:** The existing 6-foot-diameter and 10-foot by 7-foot box sanitary sewers will need to be verified. TJPA plans to relocate the sewer as part of the DTX project to a location in the vicinity of the Folsom Area Stormwater Improvement Project tunnel.
- **King Street:** A electrical distribution line running along King Street has been identified, and depths and sizes will need to be verified in future phases. The electrical lines intersect the various proposed alignments at this location.

- **Intersection of Berry Street and Alternative C Easterly Alignment:** A 4-foot sanitary sewer along the northeast portion of Berry Street has been identified crossing the Alternative C alignment. The location and depth of this sanitary sewer will need to be verified.
- **Folsom Area Stormwater Improvement Project:** This is a proposed project that is a part of the San Francisco Public Utilities Commission's (SFPUC) flood resilience efforts under the Sewer System Improvement Program (SSIP). The current proposed crossing location is at Berry Street and 7th Street. In the vicinity of the PAX alignments, the tunnel is 15 feet outside diameter, with an approximate invert elevation of -35 feet (Datum: NAVD88). The low-lying Inner Mission neighborhood surrounding 17th, 18th, and Folsom Streets has been historically subject to flooding during moderate to heavy storms. The impact of this planned tunnel on PAX tunneling is that it drives the PAX tunnel deeper.
- **Division Street Sewer Crossings at 7th Street and Berry Street:** The Division Street Box Sewer serves as the main sewer that currently drains the Folsom area in the Mission neighborhood of San Francisco. The sewer runs from the intersection of Harrison Street and Treat Avenue to the Channel Pump Station and Outfall located adjacent to 7th Street. The sewer was designed and constructed in four different phases from 1908 to 1968. The sewer consists of independent compartments, or box structures, that convey combined sanitary and stormwater flows. The number of boxes vary from two to four along the sewer length. The Division Street Box Sewer will cross above the proposed alignments between the intersection of Berry Street/Channel Street and 7th Street as shown in Figure 7-23. Near Berry Street, the Division Street Box Sewer consists of four individual boxes that measure approximately 8'3" by 9'6". The three boxes on the south side of the sewer are supported on wooden pile foundations and were designed in 1906. The box on the north side is supported on steel pipe piles and was designed in 1968. The depth of the box sanitary sewer and piles will need to be verified in future investigations.
- **7th Street:** A box sanitary sewer sized at 3' by 4'6" runs along 7th Street in the PAX corridor. The box sewer may be supported on piles in this location. Future phases shall investigate if this box sewer is supported on piles and determine the type, depth, and location of these piles.
- **16th Street:** A number of utilities have been identified as crossing the proposed PAX corridor at 16th Street. The depths and locations of utilities along 16th Street as they cross the easterly alignment of Alternative C will need to be verified. The utilities at this location have been identified as ones that may need to be relocated if Alternative C is selected for construction.
- **Mariposa Street:** A number of utilities have been identified as crossing the proposed easterly alignment of Alternative C. The depths and locations of utilities along Mariposa Street as they cross the easterly alignment of Alternative C will need to be verified. The utilities at this location have been identified as ones that may need to be relocated if Alternative C is selected for construction.
- **36-inch Sanitary Sewer:** The physical location of a 36-inch-diameter sanitary sewer near the location of the southern portal for Tunnel 1 will need to be verified. This sanitary sewer may conflict with the proposed Alternative B1 and B2 construction.
- **Between 22nd and 23rd Street:** The depth of utilities along the proposed retaining wall for Alternatives B and C will need to be verified.

- **Pennsylvania Avenue and 23rd Street:** An existing 24-inch sanitary sewer pipe has been identified running along Pennsylvania Avenue. The location and depth of this pipe will need to be verified.

### 8.3 Anticipated Significant Relocations

During construction of the tunnel, shafts, and ventilation structures, utilities located within the project alignment would be relocated as necessary to facilitate construction. These relocations would occur during early construction in advance of other construction activities associated with the PAX project at any given location.

As the design of the project advances, the relevant utility owners will be identified, and designs for utility relocations would be developed using information from the facility owners, including determinations for the entity that will be responsible for undertaking the relocations and how the costs of the relocations will be allocated. Construction activities, including relocation of utilities, would be coordinated by a designated Utility Coordinator with the various utility companies and agencies to avoid or minimize service disruptions during construction, thus resulting in minimum impact to the public.

The utility desktop study concluded that utility relocations for Alternative C may need to occur where Track 1 (eastern track) crosses 16th Street and Mariposa Street. At 16th Street, the tunnel crown of this alignment may intercept existing utilities identified as an 8-inch sanitary sewer, 30-inch natural gas line, communication lines, varying sizes of electrical distribution, and a 16-inch water main. At Mariposa Street, the U-wall construction for the easterly track beginning at Station 1025+50 to approximately Station 1038+00 may conflict with electrical transmission and distribution of various sizes, communication lines, 16-inch auxiliary water supply system, and a pair of 16-inch water mains. The location and depths of these utilities will need to be verified in future phases, and the utilities may need to be relocated during construction.

## 9.0 Right-of-Way and Property Issues

The Preliminary Right-of-Way Acquisition Assessment is intended to identify properties that are potentially impacted by the Pennsylvania Avenue Tunnel Extension Project (PAX) and to develop an initial high-level cost estimate for the ROW program. This assessment is included as Appendix G. The primary purpose of the ROW Assessment is to evaluate the right-of-way (ROW) impacts for alternative alignments and to compare relative ROW impacts between alternatives for cost, risk, and schedule.

### 9.1 Alignment Alternatives Considered

ROW impacts and costs have been identified for three separate alignment alternatives. The alternatives considered are as follows:

- A1/A2: Long Alignment – Single Bore/Twin Bore Tunnels
- B1/B2: Mid-Length Alignment – Single Bore/Twin Bore + SEM Tunnels
- C: Short Alignment – Split Tunnels

The ROW impacts for each of these alignments are detailed in the ROW Plan. The purpose of the plan is to identify property impacts for each alternative and quantify costs and other impacts for each alternative.

### 9.2 Property Identification

Potentially impacted properties were identified for each alternative. Parcels were included if any portion of a parcel is expected to be impacted by the surface or subsurface permanent structure from a given alternative. This report does not include potential impacts from surface settlement outside the plan limits of the permanent project structures.

### 9.3 Property Valuation

Taxable property values for parcel and structures were provided by the San Francisco Assessor Office. These tax values were escalated based on the last date of sale to bring expected property values to a consistent current value. Escalation values are based on Federal Reserve published data shown in Figure 9-1. Price indexes are published for both single-family residential properties and condominiums.



**Figure 9-1. Federal Reserve Property Price Index for Condominiums (source: Federal Reserve Bank, St. Louis)**

## 9.4 Property Impacts

Property impacts are divided into properties that will potentially require full property acquisition and those requiring permanent subsurface easements without impacts at the parcel surface.

ROW impacts for properties requiring permanent subsurface easements are evaluated based on several criteria including potential future development use of the parcel, depth of subsurface impact, and the value of existing structures. The cost of ROW impacts is based on the current estimated property value and the following criteria.

### Property Acquisition

- **Commercial properties:** Estimated value has been escalated from County Assessor’s Records. If development entitlements have been obtained since the last property sale, 15% of entitled value increase will be added to the property value.
- **Residential properties:** Estimated value has been escalated from the County Assessor’s Records. In addition to fair market property value, there are additional potential relocation assistance costs in the event either residential or nonresidential displacements occur. This category can include “consequential displacements.” A consequential displacement is displacement of “a person, business, farm, or nonprofit organization from the unacquired remaining property as a direct result of acquisition for the proposed project” (Caltrans Right of Way Manual Chapter 10.011.03.07).<sup>2</sup> Temporary displacements may also be eligible for relocation assistance.

### Subsurface Easements

<sup>2</sup> See also 49 CFR Part 24 (Uniform Act.) California Government Code 7260, et seq. and California Code of Regulations, Title 25, Division 1, Chapter 6.



- **20–40 foot tunnel cover**

- **Residential:** 50% of impacted property value
- **Commercial:** 50% of value of current plus 10% of potential future development value.

This impact value is intended to account for both the cost of sub-surface easements and settlement mitigations for structures where required.

- **40+ foot tunnel cover**

- **Residential:** 20% of impacted property value.
- **Commercial:** 20% of impacted structure plus 5% of potential future development value.

The reduced impact costs for properties where the tunnel is further below ground surface is due to several factors:

- Reduced potential for ground-borne vibrations.
- Generally better ground conditions at deeper tunnel sections will produce smaller surface impacts.
- Reduced settlement mitigation requirement.
- Minimal impact to future development on the property.

### Partial Easements at Large Parcels

- **Residential and Commercial:** 10% of impacted property value.

Several large parcels are impacted over a small percentage of the overall parcel area. In these cases, a reduced easement impact was assumed.

## 9.5 Construction Staging Areas

Potential staging areas are on parcels owned by Caltrain, Caltrans, or the City and County of San Francisco. The PAX contractor may choose to lease privately owned parcels in the project area to facilitate construction of the project. Several viable parcels were identified in the vicinity of Pennsylvania Avenue and Cesar Chavez Street. Based on recent sales, tax records and appreciation, the estimated market value of these parcels is between \$4 million and \$5 million per acre. Based on a lease term of seven years and industry experience with similar construction staging leases, the total lease cost is expected to be 66% of the market value. This cost includes required site improvements and restoration at the end of the lease. This also assumes 7 acres of construction staging will be required at the high end of the property value range. The cost estimate for construction staging is summarized in Table 9-1 below.

**Table 9-1. Construction Staging Area Cost Estimate**

| Total Acres for Construction Staging | Total Property Market Value | Term of Lease (in Years) | Total Leasing Cost of Construction Staging |
|--------------------------------------|-----------------------------|--------------------------|--|
| 7.0                                  | \$35,000,000                | 7                        | \$23,000,000                               |

## 9.6 Summary of Alternative Impacts

The ROW impact estimates are summarized in Table 9-2 below. Note that these estimates do not include the estimated costs for leasing of construction staging areas included in Section 9.5.

**Table 9-2. Summary of ROW Impacts**

| <b>Alternative</b>                                     | <b>Total ROW Impact</b> |
|--|-------------------------|
| A1: Single Bore TBM                                    | \$ 70,000,000           |
| A2: Dual Bore TBM                                      | \$150,000,000           |
| B1: Single Bore TBM                                    | \$ 30,000,000           |
| B2: Dual Bore TBM                                      | \$100,000,000           |
| C1   | \$ 25,000,000           |
| Note: ROW impact estimates are considered preliminary. |                         |

## 10.0 Project Risks

Evaluation of project risk is important for the comparison of alternative alignments and development of risk response and mitigation strategies early in the project development process. A robust risk management program is also important so that the risk processes assist with informed decision-making and procurement strategy, follow-on tasks, future provision of cost and schedule contingency, as well as gaining federal funding. Two risk workshops were held in the fall of 2020 and the spring of 2021, during which the project team and the Technical Advisor Group discussed and evaluated a number of risks related to the PAX project. One additional risk workshop, reviewed proposed controls/mitigations for risks, was held in May of 2021.

### 10.1 Approach

1. **Risk Identification:** Risk identification involves members of the project team who participate in the characterization of the project and are able to identify risks to the project via a collaborative brainstorming process. Risk statements are then captured on a Risk Register, assigned an identification number, and categorized by discipline.
2. **Risk Register:** Capturing risks in a Risk Register provides a basis for further action to reduce the potential loss, or at least recognition that some project elements will not be known until they occur. Identifying these elements provides a means for analyzing the impact of these risk elements and preparing the risk response strategies to address project losses. Another benefit is to focus the project development on the most significant potential risk events and the risk response strategies to minimize their potential impacts. A systematic means of capturing these risks is through the use of a Risk Register.
3. **Workshop Process:** The Project Risk Register was developed with initial input from members of the project team and updated during a risk workshop in September 2020. The Risk Register was subsequently updated following completion of the Alternatives Analysis period. The Risk Register was again reviewed at an ensuing workshop in March 2021, at which project team members and the Technical Advisory Group (TAG) reviewed the risks previously identified on the Risk Register and evaluated the cost impact, schedule impact, and probability of occurrence for each risk.
4. **Risk Scoring:** Project risks were identified, evaluated, and scored for each alignment alternative. Risks on the Risk Register were scored so that their significance can be prioritized and tracked by the project team. Risks were measured or assessed as to:
  - Potential (and most likely) cost impact (C): Scored 1 to 5.
  - Potential (and most likely) schedule delay (T): Scored 1 to 5.
  - Probability of occurrence (P): Scored 1 to 5.
  - The total score will be arrived at through averaging the cost and schedule impact scores and multiplied by the probability score:  $(C+T) / 2 \times P = \text{Total Score}$ .
  - As an example:
    - (C) Cost Impact = 1
    - (T) Time impact = 4

- (P) Probability = 5
- Score = 1 + 4 = 5; / 2 = 2.5; x 5 = 12.5 or a “High Risk”

Table 10-1 below represents the matrix used to score and rank risks on the Risk Register:

**Table 10-1. Risk Scoring Matrix**

| Score           | Low (1)   | Med (2)    | High (3)   | Very High (4) | Significant (5) | Risk Score (Average of Cost and Schedule Impact X Probability) |
|-----------------|-----------|------------|------------|---------------|-----------------|--|
| (C) Cost        | < \$2M    | \$2–5M     | \$5–10M    | \$10–50M      | > \$50M         | High > 10  |
| (T) Time        | < 1 Month | 1–3 Months | 3–6 Months | 6–12 Months   | >12 Months      | Med 3–10   |
| (P) Probability | < 10%     | 10–50%     | 50–70%     | 70–90%        | >90%            | Low <3   |

5. **Risk Response:** Risk response planning includes mitigations through avoidance, transfer to the party best equipped to manage, and attempts to control the likelihood and/or magnitude of the consequences. However, some risks are unavoidable and must be accepted and addressed through the issuance of insurance, or consumption of planned cost contingency or schedule float when appropriate. As a next step, project risk responses should be developed for each risk on the Risk Register. Risk response planning should identify the response approach, an action, an appropriate “owner” of the response, and a due date for implementation.

## 10.2 Findings

1. The compiled Risk Register is included in this report as Appendix H. A total of 47 risks have been identified for the project.
2. Major risks identified in the Risk Registry include risks in the following areas:
  - a. Settlement from tunneling operations;
  - b. Impacts to existing utilities;
  - c. Impacts to rail operations during construction;
  - d. Coordination with the DTX and Railyards projects;
  - e. Impacts to infrastructure including the I-280 viaduct and existing Caltrain tunnels;
  - f. Responsibility for ownership/operations; and
  - g. Project funding.
3. Table 10-2 shows risks receiving a high score in one or more of the alignment alternatives. Based on the risk scoring matrix (Table 10-1), Alignment Alternative C had the largest quantity of “high” scored risks with 11; Alignment Alternatives A1, A2, and B2 each had 9 “high” scored risks, and Alignment Alternative B1 had 8 “high” scored risks. Note that the number of “high” scored risks alone does not present the full picture of the risk assessment that was performed and must be reviewed along with Figure 10-1, which provides a summary of the quantities of “high,” “medium,” and “low” scored risks across each alignment alternative.

**Table 10-2. “High” Scored Risks by Alignment Alternative**

| <b>ID</b> | <b>Risk Description</b>  | <b>A1</b> | <b>A2</b> | <b>B1</b> | <b>B2</b> | <b>C</b>  |
|-----------|--|-----------|-----------|-----------|-----------|-----------|
| 1         | Mixed-face (rock and soil) mining causes ground loss   | ✓         |           | ✓         |           |           |
| 3         | Liquefaction during earthquake requires repairs to the permanent structure                             |           |           |           |           | ✓         |
| 7         | Less than favorable ground conditions at south portal require additional support                       | ✓         |           |           |           |           |
| 8         | Specialized work limits bidders and increases costs beyond established budget                          | ✓         |           | ✓         |           | ✓         |
| 9         | Limited staging areas increase general condition costs of contractor                                   |           |           |           |           | ✓         |
| 10        | Limited work windows negatively impact contractor production rates                                     |           |           |           |           | ✓         |
| 11        | General utility impacts from settlement necessitate unplanned repair and restoration                   | ✓         | ✓         | ✓         | ✓         |           |
| 12        | Phasing of project into separate packages increases schedule   |           |           |           |           | ✓         |
| 16        | Caltrans freeway bridge piers impact TBM operation   |           | ✓         |           | ✓         | ✓         |
| 18        | DTX tie-in impacts system operations   | ✓         | ✓         | ✓         | ✓         | ✓         |
| 19        | Railyards development timing impacts PAX schedule  | ✓         | ✓         | ✓         | ✓         | ✓         |
| 24        | Relocation of 22nd Street Station increases project cost—federal process may require justification     | ✓         | ✓         |           |           |           |
| 27        | Limited public right-of-way on 7th Street increases right-of-way costs                                 |           | ✓         |           | ✓         |           |
| 29        | Development of property at 17th and Pennsylvania drives up acquisition costs or leads to late redesign |           | ✓         |           | ✓         |           |
| 32        | Curves and grades increase maintenance and may drive up future operational costs                       |           |           | ✓         | ✓         |           |
| 39        | Construction dust and air pollution lead to potential fines and or additional mitigations              |           |           |           |           | ✓         |
| 43        | Political support is insufficient, requiring additional studies or analysis                            |           |           |           |           | ✓         |
| 44        | Sufficient construction funding does not become available  | ✓         | ✓         | ✓         | ✓         | ✓         |
| 45        | Responsibility for ownership/operations cannot be determined   | ✓         | ✓         | ✓         | ✓         |           |
|           | <b>Total</b>   | <b>9</b>  | <b>9</b>  | <b>8</b>  | <b>9</b>  | <b>11</b> |

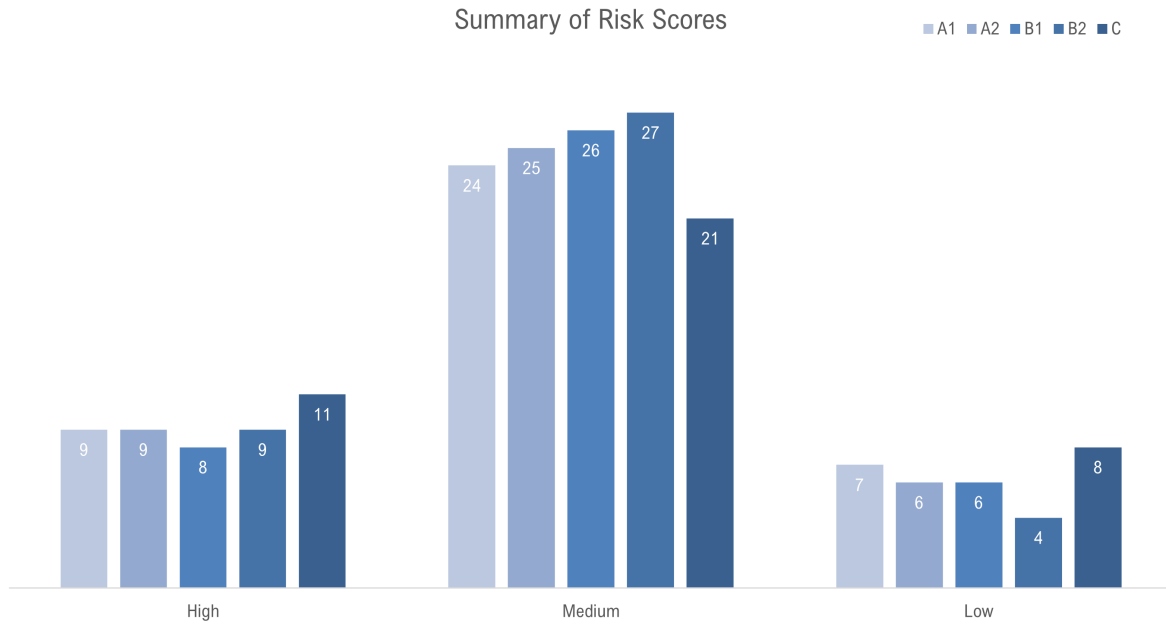

**Figure 10-1. Summary of Risk Scores by Alignment Alternative**

## 11.0 Project Schedule and Costs

### 11.1 Approach

Conceptual project cost estimates and schedules were prepared using pricing data from recent detailed production-based cost estimates for similar work and adjusted as needed for quantities and special conditions unique to the PAX alignments. An example of special conditions is the low operating headroom under the I-280 viaduct that will require specialized construction equipment. For some project components such as internally braced excavations, concrete structures, and the I-280 column retrofits, detailed takeoffs were performed and priced. Specialty construction items such as slurry wall construction and ground improvement were estimated based on anticipated quantities and recent subcontract quotes adjusted for the constrained site conditions. For other complex work with unknown scope, such as the Folsom Street Sewer protection in place for Alternative C, budgetary cost and schedule numbers were used.

Design and construction criteria were established based on available information, and associated risk was priced directly into the work when it was deemed to have a high probability of occurring. An example of this is the need for ground improvement between twin bores for the indicated configurations of Alternatives A2 and B2.

Estimates were prepared using current costs, escalated to the mid-point of construction, and rounded up to the nearest \$10 million. Escalation was informed by producer price indices data for the past 3 years obtained from the U.S. Bureau of Labor Statistics website (<http://data.bls.gov/cgi-bin/srgate>) for a weighted “basket of goods” comprising labor, materials, and equipment. Escalation for the basket of goods amounts to 3.1% per year.

The COVID-19 pandemic has created significant uncertainty in the markets. The same basket of goods evaluated each year for 2018, 2019, and 2020 resulted in annual escalation rates of 4.6%, -0.6%, and 4.8%, respectively. Looking forward, continued volatility is likely as the manufacturing and shipping industries reopen plants and gear up for as-yet uncertain post-pandemic production rates, while financial markets face concerns with increased inflation. Such volatility should continue to be expected for the short term. We considered a long-term average escalation rate of 5% over the life of the project as appropriate, to be consistent with TJPA’s approach and to be conservative in the current inflationary environment.

“Soft costs” such as design, project management, construction management, and owner administration were estimated based on historical soft costs from other similar transportation projects and a publication by the Transportation Research Board’s Transit Cooperative Research Program (TCRP) Report 138: *Estimating Soft Costs for Major Public Transportation Fixed Guideway Projects* (TRP, 2010). A 20% contingency for soft costs was applied. A range of soft costs was determined for each alternative, with the low end assuming a three-year period for preconstruction activities and a 4-year period for the high end. Soft costs including contingency vary from \$197 million for a 3-year preconstruction period to \$310 million for a 4-year preconstruction period, or approximately 19% to 30% of an average construction cost for the alternatives. Since the level of effort associated with soft costs is not expected to vary significantly between the construction alternatives, \$310 million was used for all alternatives.

An additional 50% allowance was included for project contingency on construction costs and is an appropriate amount to carry at this conceptual stage of project definition. Summarized cost and schedule durations are presented in Table 11-1 and Table 11-2. A detailed project schedule and cost estimate for each alternative are provided in Appendix I and Appendix J, respectively.

## 11.2 Cost

The cost range between project alternatives is also relatively narrow: Alternative C at \$2,010 million has an 18% lower cost than the highest cost of \$2,450 million for Alternative A2. The lowest estimated cost among alternatives A1, A2, B1, and B2 is B1 at 13% below the most expensive estimated alternative (A2). This low cost spread between alternatives indicates that selection of the preferred alternative will not be significantly influenced by cost. The cost of the station configuration and components that is associated with each alternative (as shown in Table 11-1 below) and the risk profiles for each alternative will likely be the overriding criteria in determining the preferred alternative. It should be noted that the cost ranges for the alternatives do not address station design and construction, which are outside the scope of this study. New trackwork where required in the 22nd Street Station area is included in the proposed cost.

**Table 11-1. Cost of Station Configuration and Components by Alternative**

| Component   | (millions)        |                   |                   |                   |                   |
|---|-------------------|-------------------|-------------------|-------------------|-------------------|
|   | A1                | A2                | B1                | B2                | C1                |
| <b>Construction Costs<sup>1</sup></b>                   | <b>\$730</b>      | <b>\$780</b>      | <b>\$710</b>      | <b>\$700</b>      | <b>\$690</b>      |
| Construction Midpoint <sup>2</sup>                      | 10.1 years        | 10.2 years        | 10.3 years        | 10.1 years        | 9.5 years         |
| <b>Escalated Construction Costs<sup>3</sup></b>         | <b>\$1,200</b>    | <b>\$1,290</b>    | <b>\$1,180</b>    | <b>\$1,150</b>    | <b>\$1,100</b>    |
| ROW <sup>1</sup>  | \$90              | \$170             | \$50              | \$120             | \$40              |
| ROW Acquisition Midpoint                                | 3.1 years         | 3.1 years         | 3.1 years         | 3.1 years         | 3.1 years         |
| <b>Escalated ROW Costs<sup>3</sup></b>                  | <b>\$110</b>      | <b>\$200</b>      | <b>\$60</b>       | <b>\$140</b>      | <b>\$50</b>       |
| <b>Soft Costs<sup>4</sup></b>                           | <b>\$310</b>      | <b>\$310</b>      | <b>\$310</b>      | <b>\$310</b>      | <b>\$310</b>      |
| <b>Contingency</b>                                      | <b>\$600</b>      | <b>\$650</b>      | <b>\$590</b>      | <b>\$580</b>      | <b>\$550</b>      |
| <b>Escalated ROW Costs, Soft Costs, and Contingency</b> | <b>\$1,020</b>    | <b>\$1,160</b>    | <b>\$960</b>      | <b>\$1,030</b>    | <b>\$910</b>      |
| <b>Total Project Cost</b>                               | <b>\$2,220</b>    | <b>\$2,450</b>    | <b>\$2,140</b>    | <b>\$2,180</b>    | <b>\$2,010</b>    |
| <b>Total Project Duration</b>                           | <b>13.3 years</b> | <b>13.5 years</b> | <b>13.6 years</b> | <b>13.2 years</b> | <b>11.9 years</b> |

<sup>1</sup>Q4 2021 Cost Basis

<sup>2</sup>Based on construction schedule prepared on 2/24/2022

<sup>3</sup>Escalation carried at 5% PA

<sup>4</sup>Including \$2M Bridging Study

## 11.3 Schedule

Project schedules based on major construction activities were prepared for each alternative, allowing for a 78-month period for CEQA clearance, real estate procurement, preliminary and final design, and construction contract procurement. It should be noted that no contingency has been applied to the project alternatives schedules on the basis that schedule risk will be addressed during subsequent project definition. Project schedules for the alternatives are summarized in Table 11-2 below.



**Table 11-2. Project Schedule Summaries for Alternatives**

|   | 2022 | 2023 | 2024 | 2025 | 2026 | 2027 | 2028 | 2029 | 2030 | 2031 | 2032 | 2033 | 2034 | 2035 | 2036 |  |
|---|------|------|------|------|------|------|------|------|------|------|------|------|------|------|------|--|
| Bridging Study  | █    |      |      |      |      |      |      |      |      |      |      |      |      |      |      |  |
| Environmental Clearance/ Preliminary Engineering<br>ROW/Final Design/ Procurement |      | █    |      |      |      | █    |      |      |      |      |      |      |      |      |      |  |
| Alt A1 Construction   |      |      |      |      |      |      |      | █    |      |      |      |      |      |      |      |  |
| Alt A1 Startup/Testing Complete   |      |      |      |      |      |      |      |      |      |      |      |      |      |      | ◆    |  |
| Alt A2 Construction   |      |      |      |      |      |      |      | █    |      |      |      |      |      |      |      |  |
| Alt A2 Startup/Testing Complete   |      |      |      |      |      |      |      |      |      |      |      |      |      |      | ◆    |  |
| Alt B1 Construction   |      |      |      |      |      |      |      | █    |      |      |      |      |      |      |      |  |
| Alt B1 Startup/Testing Complete   |      |      |      |      |      |      |      |      |      |      |      |      |      |      | ◆    |  |
| Alt B2 Construction   |      |      |      |      |      |      |      | █    |      |      |      |      |      |      |      |  |
| Alt B2 Startup/Testing Complete   |      |      |      |      |      |      |      |      |      |      |      |      |      |      | ◆    |  |
| Alt C Construction  |      |      |      |      |      |      |      | █    |      |      |      |      |      |      |      |  |
| Alt C Startup/Testing Complete  |      |      |      |      |      |      |      |      |      |      |      |      |      | ◆    |      |  |

The alternatives have an estimated duration of 11.9 to 13.6 years, which is inclusive of the remaining project development activities and construction. This relatively narrow range between alternatives indicates that selection of the preferred alternative will not be significantly influenced by schedule.

## 12.0 Environmental, Cultural, and Historic Studies

### 12.1 Findings of Studies Completed

#### 12.1.1 Traffic

An initial traffic impact study (Appendix K) was undertaken that evaluated the delay that could be caused by excavation haul traffic on various intersections associated with the construction of the PAX project. The study modeled roadway traffic volume growth between the years 2015 and 2035 to assess future intersection changes and traffic volumes in a no-build scenario (without the project). In the analysis of the five alternative alignments, the traffic analysis also considered options for north and south tunnel bore starts to assess potential effects on traffic delays during construction/excavation.

Under existing conditions and under a no-build scenario level of service (LOS),<sup>3</sup> degradation (meaning significant increases in traffic delays) was notable both during AM and PM peak hours for nearly all intersections in the study area. Under the project, the only alternatives that would result in notable impacts on LOS during AM peak hours would be Alternatives A1 and A2, where Pennsylvania Avenue / Cesar Chavez Street / northbound I-280 off-ramp would be degraded from LOS E to LOS F during the construction phase. The only alternatives that would result in notable impacts on LOS during PM peak hours would be Alternatives A1, A2, B1, and B2, where both 7th Street / Brannan Street and 7th Street / 16th Street intersections would be degraded from LOS D to LOS E during project construction. All scenarios and alternatives significantly impact traffic operations except Alternative C. At least one intersection is impacted in every scenario, and Alternative A1/A2 impacts two intersections. The analysis of Alternative C showed that the study intersections could handle the additional estimated 13 trucks per hour.

The study also evaluated benefits associated with the operation of the PAX project. Under existing conditions, Caltrain crosses 16th Street and Mission Bay Drive east of 7th Street at surface or at-grade crossings. Additional delays due to the interruption of the signal cycle occur at these times for track clearance at the intersection. In future year 2035, 24 trains per hour (12 in each direction) are anticipated to be in operation, which would be associated with increases in congestion. Under a (2035) post-build scenario, traffic delays would be significantly reduced compared to no-build delays during both weekday AM and PM peak hours for the 7th Street / Mission Bay Drive and 7th Street / 16th Street intersections (from LOS F/E to LOS D/C).

#### 12.1.2 Air Quality

The assessment of potential air quality constraints was based on a qualitative evaluation of the potential impacts on nearby receptors that could result from the project. Air quality does not affect individuals or groups within the population in the same way, and some groups are more sensitive to adverse health effects caused by exposure to air pollutants than others. Population subgroups more sensitive to the health effects of air pollutants include the elderly and children, such as those with higher rates of respiratory disease (e.g., asthma and chronic obstructive pulmonary disease), or land uses such as schools, children's

---

<sup>3</sup> Additional evaluation of traffic impacts including evaluation of project-generated vehicle miles traveled would be undertaken during subsequent environmental analysis of the PAX project.

daycare centers, hospitals, and nursing and convalescent homes, which support population groups with increased susceptibility to respiratory distress.

The potential impacts for construction activities that would be associated with each of the project alternatives are described below. Regarding operations, each of the alternatives would result in the relocation of train operations belowground and the associated removal of at-grade rail crossings at busy roadways. The project would generally result in a beneficial impact associated with long-term localized reduction in vehicle exhaust emissions along the PAX corridor because of the reduction in vehicle congestion that currently exists along adjacent streets during train crossings. In addition, although not directly related to the PAX project, Caltrain is purchasing 19 new high-performance seven-car electric train sets to replace the current diesel locomotive trains.<sup>4</sup> Caltrain will electrify the corridor from San Francisco's 4th and King Caltrain Station down through San Jose. Passenger service of the new electric trains is expected to begin in 2022. One of the primary purposes of Caltrain electrification is to improve regional air quality and lower greenhouse gas emissions. Electric train service would result in decreased diesel particulate emissions within the project corridor relative to existing conditions regardless of which alternative is selected. Because the operational beneficial impacts would be the same regardless of alternative, operational impacts are not discussed below for each of the alternatives.

#### 12.1.2.1 Alternative A1

Emissions associated with tunneling would be vented to the atmosphere from either the north or south entry tunnel, three ventilation shafts along the alignment, and the south exit tunnel and ventilation shaft. These five locations represent the project's aboveground tunneling-related emissions sources, although the total emissions from the south exit tunnel and ventilation shaft would be substantially less than from the other four locations since tunnel excavation would proceed from the north. In addition to tunneling, this alternative would involve the most off-haul trips of excavated material because of the large dimensions of the single tunnel. Haul trucks would access the north entry tunnel to off-haul excavated tunnel materials.

Sensitive receptors in the vicinity of these five emission generation locations include:

- Crescent Cove apartments at Berry Street.
- A residential building at King and 7th within 150 feet and 200 feet, respectively, of the north entry tunnel and the northern-most ventilation shaft.
- Apartments approximately 100 feet from the 16th Street ventilation shaft site at 1050 17th Street.
- Single-family homes immediately adjacent to the 19th Street ventilation shaft site, and residences at 270 feet north of the southern exit tunnel and ventilation shaft. These residences would be exposed to elevated concentrations of toxic air contaminants for the duration of tunneling activities, which could pose a health risk to these neighborhoods.

---

<sup>4</sup> Obtained from Caltrain Modernization Program Overview and Electric Trains web pages at <https://calmod.org/> and <https://calmod.org/electric-trains/>.

### **12.1.2.2 Alternative A2**

Based on the combined volume of the twin tunnels under Alternative A2 relative to the volume of the single tunnel for Alternative A1, and the general assumption that excavation of a certain volume of material generates a certain mass of toxic air contaminants, this alternative would result in the generation of approximately 23% fewer toxic air contaminant emissions associated with tunneling and material hauling compared to Alternative A1. The TBMs for this alternative could be launched from the north or the south. It is presumed that most emissions associated with tunneling would be vented to the atmosphere from the north or the south entry tunnel, depending on the location of the entry tunnel, as well as from the same ventilation shaft sites discussed under Alternative A1. Haul trucks would also access the north or south entry tunnel to off-haul excavated tunnel materials. The same residential uses discussed under Alternative A1 would be affected by this alternative, potentially resulting in a health risk to these neighborhoods. Exposure concentrations in the vicinity of these residences would be elevated for the duration of tunneling activities.

### **12.1.2.3 Alternative B1**

Based on the volume of the tunnel under Alternative B1 relative to the volume of the tunnel for Alternative A1, and the general assumption that excavation of a certain volume of material generates a certain mass of toxic air contaminants, there would be generation of approximately 30% fewer toxic air contaminants from tunneling and hauling under this shorter alternative compared to Alternative A1. Emissions associated with tunneling would be vented to the atmosphere from the north entry tunnel as well as from three ventilation shaft sites. The northern two ventilation shaft sites would be at the same locations as described for Alternative 1 and therefore would expose the same residences to pollutants; however, under this alternative there would be no 19th Street ventilation shaft, and the southern-most ventilation shaft would be under the southbound lanes of Interstate 280, just north of 22nd Street. This southern ventilation shaft site is approximately 50 feet from residences along Pennsylvania Avenue. Haul trucks would access the north entry tunnel to off-haul excavated tunnel materials. Exposure to concentrations in the vicinity of these residences would be elevated for the duration of tunneling activities.

### **12.1.2.4 Alternative B2**

Based on the dimensions of the twin tunnels under Alternative B2 relative to the volume of the single tunnel for Alternative A1, and the general assumption that excavation of a certain volume of material generates a certain mass of toxic air contaminants, there would be approximately 54% fewer toxic air contaminants from tunneling and hauling under this alternative compared to Alternative A1. Emissions associated with tunneling would be vented to the atmosphere from the north entry tunnel as well as from the same three northern ventilation shaft sites as described for Alternative A1. These three ventilation shaft sites would expose the same residences to pollutants as identified for Alternative A1. Haul trucks would access the north entry tunnel to off-haul excavated tunnel materials. Exposure to concentrations in the vicinity of these residences would be elevated for the duration of tunneling activities.

### 12.1.2.5 Alternative C

It is presumed that emissions associated with tunneling would be vented to the atmosphere from the north entry tunnel as well as from approximately the same three northern ventilation shaft sites as described for Alternative A1. These three ventilation shaft sites would expose the same residences to pollutants as identified for Alternative A1. Haul trucks would access the entry tunnel to off-haul excavated tunnel materials. Exposure to concentrations in the vicinity of these residences would be elevated for the duration of tunnel-boring activities. However, emissions associated with cut-and-cover techniques under Alternative C would be released to the atmosphere where they are generated along the alignment. This would result in lower emission concentrations at the north entry tunnel and ventilation shaft sites compared to the two southern ventilation shaft sites, as well as lower emission concentrations at any one location along the cut-and-cover alignment compared to at the north entry tunnel and ventilation shaft sites under the other alternatives since cut-and-cover work would proceed in open-air conditions at a linear pace along the alignment. Such release along the alignment would thus have the effect of diluting pollutants emitted to the atmosphere at any single location along the length of the cut-and-cover alignment as opposed to emitting more concentrated emissions at the discrete ventilation point locations (i.e., at the north entry tunnel as well as the three northern ventilation shaft sites).

### 12.1.3 Noise and Vibration

The assessment of potential constraints associated with noise and vibration was based on a qualitative evaluation of the potential impacts on nearby noise and vibration receptors that could result from the project. The evaluation of construction impacts reflected consideration of the duration of construction, type of construction (e.g., pile driving), and proximity of construction and staging areas to sensitive receptors such as residences as well as to each other. The evaluation of operational impacts considered the proposed depth of tunnels and proximity of these tunnels to sensitive receptors.

Some land uses are considered more sensitive to ambient noise levels than others because of the amount of noise exposure (in terms of both the duration of exposure and insulation from noise) and the types of activities typically involved. Residences, motels and hotels, schools, libraries, churches, hospitals, nursing homes, and auditoriums generally are more sensitive to noise and vibration than are commercial and industrial land uses. Residential uses exist at the northern end of the project alignment as close as 150 feet.

The designation of vibration-sensitive land uses depends not only on the type of activities commonly associated with a given land use, but also considers nearby structures that could be damaged by vibration-inducing activities. More than a dozen historic architectural resources are located within or adjacent to the project corridor (refer to Section 12.1.5). High-sensitivity uses also include land uses where vibrations would interfere with interior operations and include hospitals, research operations, television and recording studios, and concert halls.

### 12.1.3.1 Alternative A1

#### Construction Noise

Although this alternative would have the longest tunnel, it would be excavated using a TBM as opposed to cut-and-cover techniques; as such, only the tunnel portals and ventilation shaft portals would experience at-grade construction noise. Therefore, construction noise impacts would be focused at the two tunnel portal ends and, to a much lesser degree, the three ventilation shaft portals. Excavation portals under this alternative would be more than 150 feet from the closest noise-sensitive receptors at the northern portal, while residences located north of 25th Street would be within 270 feet of the southern portal. However, existing ambient noise levels at these receptors are already high because of the presence of the I-280 ramp flyovers, so the increase in noise over ambient conditions would not be expected to be substantial. This alternative would have the greatest number of trucks being loaded to off-haul excavated materials from the portals, which would have a moderate impact on noise levels along roadways used to access the freeway.

#### Construction Vibration

Depending on the method employed, support of excavation for the cut-and-cover structure at the DTX/PAX interface and TBM operations could have vibration impacts depending on depth of tunnel, underlying soil types, and overlying land uses such as residences or biotech facilities with vibration-sensitive equipment (e.g., MRI or electron microscopy). However, the distance of tunnel portals from the nearest structure is likely sufficient to avoid building damage or sensitive equipment impacts.

#### Operational Noise

Overall, Alternative A1 would result in beneficial operational noise impacts within the project corridor as a result of at-grade rail operations being relocated within a new tunnel and the removal of at-grade crossings at Mission Bay Drive and 16th Street, which generate noise during train crossings from warning bells and required horn blasts. The four ventilation shafts would represent potential new noise sources that would have to be evaluated with respect to Federal Transit Administration criteria for each location established in its *Transit Noise and Vibration Impact Assessment Manual* (FTA, 2018).

#### Operational Vibration

The realignment of rail tracks from at-grade to underground would result in vibrations from rail operations being generated in new locations. The Alternative A1 tunnel would relocate existing rail operations to locations directly beneath six existing residential uses at Pennsylvania Avenue and 25th Street, as well as under Pennsylvania Avenue where residential uses exist on both sides of the street from Mariposa Street to 22nd Street. The FTA would likely require a quantitative analysis of the potential vibration-related operational impacts associated with the selected alternative. Typically, the heavier the transit structure, the lower the vibration levels. The vibration levels from a cut-and-cover concrete double-box subway can be assumed to be lower than the vibration from a lightweight concrete-lined bored tunnel (FTA, 2018). As tunneling generates greater operational vibration than a cut-and-cover concrete double-box subway, Alternative A1, like all tunneled alternatives, would generate more operational vibration than Alternative C.

### 12.1.3.2 Alternative A2

#### Construction Noise

This alternative would likely have the longest duration of construction and noise impacts associated with the use of TBMs. This alternative would have a reduced number of trucks being loaded to off-haul excavated materials from the portals compared to Alternative A1 because of the reduction in excavated material. Excavation portals under this alternative would be at the same locations as Alternative A1 and would result in the same impacts on noise sensitive receptors. Consequently, other than a slightly reduced construction duration, the construction noise impacts associated with Alternative A2 would be the same as Alternative A1.

#### Construction Vibration

Depending on the method employed, support of excavation for the cut-and-cover structure at the DTX/PAX interface and TBM operations could have vibration impacts depending on depth of tunnel, underlying soil types, and overlying land uses such as residences or biotech facilities with vibration-sensitive equipment (e.g., MRI or electron microscopy). However, the distance of tunnel portals from the nearest structure is likely sufficient to avoid building damage or sensitive-equipment impacts. Consequently, other than a slightly reduced construction duration, the construction vibration impacts associated with Alternative A2 would be the same as Alternative A1.

#### Operational Noise

Operational noise impacts associated with Alternative A2 would generally be beneficial and would be the same as described for Alternative A1.

#### Operational Vibration

The realignment of rail tracks from at grade to underground would result in vibrations from rail operations being generated in new locations. The proposed tunnel would relocate existing rail operations to locations directly beneath six existing residential uses at Pennsylvania Avenue and 25th Street, as well as under Pennsylvania Avenue where residential uses exist on both sides of the street from Mariposa Street to 22nd Street. The western bore would be directly beneath existing residential uses on the west side of 7th Street between Hubbell Street and 16th Street and at the corners of 17th Street and Pennsylvania Avenue. The FTA would likely require a quantitative analysis of the potential vibration-related operational impacts associated with the preferred alternative. The potential for operational vibration impacts associated with Alternative A2 would be greater than for Alternative A1 because of the western tunnel bore locating railroad operations directly below more residential uses. As tunneling generates greater operational vibration than a cut-and-cover concrete double-box subway, Alternative A2, like all tunneled alternatives, would generate more operational vibration than Alternative C.

### 12.1.3.3 Alternative B1

#### Construction Noise

Although SEM work would involve excavators, the work would be conducted within a tunnel such that only the spur tunnel portals would experience at-grade construction noise. This alternative would likely have a shorter duration of construction and associated noise impacts because of the reduced tunnel lengths compared to Alternatives A1 and A2 and would have a reduced number of trucks being loaded to off-haul excavated materials from the portals because of the reduction in excavated material. The northern excavation portal under this alternative is at the same location as for Alternatives A1 and A2 and so is at the same distance to noise-sensitive receptors. The southern portal at 22nd Street has residential uses nearby. Consequently, because of reduced duration of construction and reduced truck trips compared to Alternatives A1 and A2, Alternative B1 would have a reduced potential for construction-related noise impacts.

#### Construction Vibration

Depending on the method employed, support of excavation for the cut-and-cover structure at the DTX/PAX interface and TBM operations could have vibration impacts depending on depth of tunnel, underlying soil types, and overlying land uses such as residences or facilities with vibration-sensitive equipment. However, the distance of tunnel portals from the nearest structure is likely sufficient to avoid building damage impacts. Consequently, other than a slightly reduced construction duration, the construction vibration impacts associated with Alternative B1 would be similar but slightly reduced in comparison to Alternatives A1 and A2.

#### Operational Noise

Operational noise impacts associated with Alternative B1 would generally be beneficial and would be similar to those of Alternatives A1 and A2.

#### Operational Vibration

The realignment of rail tracks from at-grade to underground would result in vibrations from rail operations being generated in new locations. The proposed tunnel would relocate existing rail operations to locations directly beneath 18 existing residential uses on the 500 block of Pennsylvania Avenue at 20th Street, as well as under Pennsylvania Avenue where residential uses exist on both sides of the street from Mariposa Street to 20th Street. The FTA would likely require a quantitative analysis of the potential vibration-related operational impacts associated with the preferred alternative. The potential for operational vibration impacts associated with Alternative B1 would be greater than for Alternatives A1 and A2, because of the tunnel bore locating railroad operations directly below more residential uses. Like Alternatives A1 and A2, Alternative B1 would have the potential for greater operational vibration generation than Alternative C because a bored tunnel generates more vibration than cut-and-cover concrete double-box subway.



### 12.1.3.4 Alternative B2

#### Construction Noise

Although SEM work would involve excavators, construction of this alternative would primarily be conducted within a tunnel such that only the spur tunnel portals would experience at-grade construction noise. This alternative would likely have a shorter duration of construction and associated noise impacts because of the reduced tunnel lengths compared to Alternatives A1, A2, and B1 and would have a reduced number of trucks being loaded to off-haul excavated materials from the portals because of the reduction in excavated material. The northern excavation portal under this alternative is at the same location as for Alternatives A1, A2, and B1, so is at the same distance from noise sensitive receptors. The southern portal at 22nd Street has residential uses nearby. Consequently, because of reduced duration of construction and reduced truck trips compared to Alternatives A1, A2, and B1, Alternative B2 would have a reduced potential for construction-related noise impacts.

#### Construction Vibration

Depending on the method employed, support of excavation for the cut-and-cover structure at the DTX/PAX interface and TBM operations could have vibration impacts depending on depth of tunnel, underlying soil types, and overlying land uses such as residences or facilities with vibration-sensitive equipment. However, the distance of tunnel portals from the nearest structure is likely sufficient to avoid building damage impacts. Consequently, other than a slightly reduced construction duration, the construction vibration impacts associated with Alternative B2 would be similar but reduced in comparison to Alternatives A1, A2, and B1.

#### Operational Noise

Operational noise impacts associated with Alternative B2 would generally be beneficial and would be the similar to those of Alternatives A1, A2, and B1.

#### Operational Vibration

The potential for operational vibration impacts associated with Alternative B2 would be similar to Alternative B1, and greater than Alternatives A1 and A2, because of the tunnel bore locating railroad operations directly below more residential uses. Like Alternatives A1, A2, and B1, Alternative B2 would have the potential for greater operational vibration generation than Alternative C because a bored tunnel generates more vibration than a cut-and-cover concrete double-box subway.

### 12.1.3.5 Alternative C

#### Construction Noise

Cut-and-cover work would result in exposed at-grade excavation not associated with other alternatives that would occur over the length of the northbound (easterly) box from the DTX/PAX interface to the northern portal of Tunnel 1. TBM operations in the westerly tunnel would only generate noise at the portals' locations where soil and muck are removed.

This alternative would likely have a shorter duration of construction and associated noise impacts because of the reduced tunnel lengths compared to Alternatives A1 and A2. It would be similar to Alternatives B1 and B2 in that it would have a reduced number of trucks being loaded to off-haul excavated materials from the portals because of the reduction in excavated material compared to Alternatives A1, A2, and B2. The northern excavation portal under this alternative is at the same location as Alternatives A1, A2, B1, and B2, so is at the same distance from noise-sensitive receptors. The southern portal at 22nd Street has residential uses nearby. However, because of the requirements for cut-and-cover work along 7th Street, Alternative C would have the greatest potential for construction-related noise impacts.

### **Construction Vibration**

Depending on the method employed, support of excavation for the cut-and-cover structure at the DTX/PAX interface and TBM operations could have vibration impacts depending on depth of tunnel, underlying soil types, and overlying land uses such as residences or facilities with vibration-sensitive equipment. However, the distance of tunnel portals from the nearest structure is likely sufficient to avoid building damage impacts. Consequently, the construction vibration impacts associated with Alternative C would be similar to all other alternatives unless sheet piles are required for shoring of the cut-and-cover trench.

### **Operational Noise**

Overall, the proposed Alternative Alignment C would result in beneficial operational noise impacts within the alignment study area resulting from at-grade rail operations being relocated to within the proposed tunnel and from the removal of at-grade crossings at Mission Bay Drive and 16th Street with their associated warning bells and required horn blasts. The three ventilation shafts would represent potential new noise sources that would have to be evaluated with respect to FTA criteria for each location established in the *Transit Noise and Vibration Impact Assessment Manual* (FTA, 2018). Consequently, the operational noise impacts associated with Alternative C would generally be beneficial and would be the similar to those of the other alternatives.

### **Operational Vibration**

The potential for operational vibration impacts associated with Alternative C would be similar to but greater than Alternatives A1 and A2 because of the tunnel bore locating railroad operations directly below more residential uses but less than those of Alternatives B1 and B2 as a result of reduced tunneling. In addition, the cut-and-cover concrete box subway proposed for the easterly tunnel under Alternative C could reduce vibration impacts along this route compared to the other alternatives.

#### **12.1.4 Archaeological Resources**

The evaluation of archaeological resources was based on a qualitative assessment of potentially adverse effects or significant impacts on archaeological resources that qualify for listing on the California Register of Historical Resources (California Register) or the National Register of Historic Places (National Register), or soils and landforms that may contain archaeological resources potentially eligible for either register. The evaluation considers factors such as sensitivity of landform for buried archaeological

resources, and the potential for construction activities to affect archaeological resources potentially eligible for either the California Register or the National Register.

No archaeological resources have been previously identified within the corridor or buffer area. The geotechnical report prepared for the PAX project (MJ/Slate, 2022b) identified that bedrock is located at the surface in the middle and southern end of the alignment. In these areas, there is a very low potential for archaeological resources on the surface and no potential for buried archaeological resources. Soils are present at the northern and south-central portion of the alignment. In these areas, soil stratigraphy can be generalized as artificial fill at the top 0 to 20 feet, which overlies Young Bay Mud that varies in thickness from 20 to up to 100 feet in depth. The layers below the Young Bay Mud vary throughout the alignment, but generally, below the Young Bay Mud is Colma Sand, Old Bay Clay, Alluvium/Colluvium, and then bedrock.

Artificial fill is sensitive for historical-era archaeological resources associated with early San Francisco settlement and development. Following the 1906 earthquake and fire, mass grading and landfill occurred throughout all affected areas of the City, with the goal to remove and dispose of rubble so that reconstruction could begin. Rubble from former structures was off-hauled or incorporated into underlying soils to create a new surface for redevelopment. These soils may also contain redeposited prehistoric material, which would have been disturbed as the reclamation of the San Francisco Bay occurred and during the post–Great Fire reconstruction. Younger Bay Mud and underlying soils have sensitivity for prehistoric archaeological resources (Meyer and Brandy, 2019). In general, this sensitivity is highest in Young Bay Mud and decreases with the age of soils.

The northern end of the alignment, in Mission Bay, was increasingly underwater between 8,000 and 2,000 years before present because of sea level rise (Meyer and Brandy, 2019). While the submerged areas were not accessible during this time period, the margin where the land and water met may have been a location of heightened prehistoric activity because of the important food and materials present along the shoreline. The northern portion of the alignment was within the tidal marsh of Mission Bay until the 1860s, when land reclamation efforts began. Before land reclamation efforts began, historical maps do not depict any maritime features, such as wharves or piers, within the northern portion of the alignment, and the water was very shallow, likely precluding maritime activities except possibly fishing camps.

The exact depth of previous disturbance of the soils along the proposed alignments is unknown. It is likely that in some areas previous construction has disturbed existing soils; however, the exact depth and extent of this disturbance are unknown.

#### **12.1.4.1 Alternative A1**

This alternative would require extensive soil disturbance. The total volume of soil disturbed would be the highest for all of the alignments; therefore, this alternative would have the highest potential to impact cultural resources. This alternative would require tunneling through Young Bay Mud soils at the northern end of the project corridor. These soils are considered moderately sensitive for prehistoric archaeological resources. Artificial fill at the northern end of the project corridor may also be sensitive for historical-era archaeological resources (Meyer and Brandy, 2019).

#### **12.1.4.2 Alternative A2**

This alternative would require a reduced amount of soil disturbance in comparison to Alternative A1, but because of the length of the proposed tunnel, still has a high potential to impact cultural resources. Alternative A2 would have similar but slightly reduced impacts in comparison to Alternative A1.

#### **12.1.4.3 Alternative B1**

This alternative would result in less soil disturbance than Alternatives A1 and A2 because of reduced tunnel length. Alternative B1 would have similar but slightly reduced impacts in comparison to Alternatives A1 and A2.

#### **12.1.4.4 Alternative B2**

This alternative would include slightly less soil disturbance than Alternative B1 and would have similar but slightly reduced impacts on archaeological resources.

#### **12.1.4.5 Alternative C**

This alternative would include a similar volume of soil disturbance as Alternatives B1 and B2. However, it would be excavated using a TBM and cut-and-cover techniques. Cut-and-cover work would result in exposed at-grade excavation. Cut-and-cover methods disturb a large amount of soil and would be used for Alternative C in a location that has moderate to high sensitivity for archaeological resources. Similar to other alternatives, Alternative C would require construction within Young Bay Mud soils that are moderately sensitive for prehistoric archaeological resources. Artificial fill at the northern end of the project corridor may also be sensitive for historical-era archaeological resources. Therefore, this alternative would have the highest potential to impact archaeological resources.

### **12.1.5 Cultural and Historic Resources**

The evaluation of historic architectural resources was based on a qualitative assessment that considered potentially adverse impacts on resources that qualify for listing on the California Register and/or the National Register or on a property regulated by the U.S. Department of Transportation (DOT) under Section 4(f) of the Department of Transportation Act. Under Section 4(f),<sup>5</sup> a historic site must be of

---

<sup>5</sup> Resources regulated under Section 4(f) also include public parks and recreation lands (Figure 2). There are several parks located within or close to the project corridor including the Tunnel Top Community park located at the southern end of the project corridor. Although it is not anticipated that any parks would be directly impacted by the PAX project, these resources could be indirectly impacted during project construction as a result of construction noise, emissions, and traffic. Potential impacts on and appropriate mitigation for these resources would be evaluated in detail at the next stage of environmental review.

national, state, or local significance and be listed on or eligible for listing on the National Register under Criteria<sup>6</sup> A, B, and/or C.

More than a dozen historic architectural resources are located within or adjacent to the project corridor as follows:

- Historic resources located within the project corridor:
  - Bridges and Tunnels Historic District (eligible for listing on the National Register and California Register under Criteria A/1 and considered a Section 4(f) historic site; see description below)
  - 700–768 7th Street, Baker and Hamilton Building (San Francisco Landmark No. 193)
  - 600 Townsend Street, Charles Harley Co. (eligible for listing on the National Register as an individual resource under Criterion C and considered a Section 4(f) historic site)
- 300 Pennsylvania Avenue, Captain Adams House (included in the 1968 *Here Today* architectural survey [Olmsted and Watkins], which is an adopted local register)
  - 301 Pennsylvania Avenue, Richards House (eligible for listing on the California Register as an individual resource under Criteria 1 and 3)<sup>7</sup>
  - 331 Pennsylvania Avenue, Union Iron Works/Bethlehem Steel Co. Hospital (eligible for listing on the California Register as an individual resource under Criteria 1 and 3)<sup>8</sup>

---

<sup>6</sup> National Register Criteria consider the quality of significance in American history, architecture, archeology, engineering, and culture that is present in districts, sites, buildings, structures, and objects that possess integrity of location, design, setting, materials, workmanship, feeling, and association, and:

- Criterion A. That are associated with events that have made a significant contribution to the broad patterns of our history;
- Criterion B. That are associated with the lives of persons significant in our past; and
- Criterion C. That embody the distinctive characteristics of a type, period, or method of construction, or that represent the work of a master, or that possess high artistic values, or that represent a significant and distinguishable entity whose components may lack individual distinction.

<sup>7</sup> Documentation regarding the historic status of 301 Pennsylvania Avenue on file at the San Francisco Planning Department is inconsistent. When it was evaluated in 2008 as part of the Showplace Square Historic Resource Survey, it was recommended as eligible for listing on the California Register as an individual resource under Criteria 1 and 3. However, at the same time it was assigned a California Historical Resource Status Code of 3S, which means that it “appears eligible for the National Register as an individual property through survey evaluation.” In order to determine if this property is in fact eligible for listing on the National Register and therefore a Section 4(f) historic site, confirmation should be requested from planning staff. See San Francisco Planning Department, *Showplace Square Historic Resource Survey Map*, accessed March 17, 2021, <https://sfplanning.org/resource/showplace-square-historic-resource-survey-map>.

<sup>8</sup> Documentation regarding the historic status of 331 Pennsylvania Avenue on file at the San Francisco Planning Department is inconsistent. When it was evaluated in 2008 as part of the Showplace Square Historic Resource Survey, it was recommended as eligible for listing on the California Register as an individual resource under Criteria 1 and 3. However, at the same time it was assigned a California Historical Resource Status Code of 3S, which means that it “appears eligible for the National Register as an individual property through survey evaluation.” In order to

- 367 Pennsylvania Avenue (included in the 1968 *Here Today* architectural survey, which is an adopted local register)
- 400 Pennsylvania Avenue (included in the 1968 *Here Today* architectural survey, which is an adopted local register)
- Historic resources located within 200 feet of the project corridor:
  - Dogpatch Historic District (designated as a historic district under Article 10 of the Planning Code, which is an adopted local register)
  - Bluxome Townsend Warehouse Historic District (eligible for listing on the California Register under Criteria 1 and 3)
  - 135 Mississippi Street, Berger & Carter Co. (eligible for listing on the California Register as an individual resource under Criterion 3)
  - 199 Mississippi Street, Potrero Exchange Hotel (eligible for listing on the California Register as an individual resource under Criterion 3)
  - 1200 17th Street (only the brick building on 17th Street is eligible for listing on the California Register as an individual resource under Criterion 1)

#### 12.1.5.1 Bridges and Tunnels Historic District

The discontinuous Bridges and Tunnels Historic District is located entirely within the project corridor. The district is composed of four contributing structures: two brick and concrete tunnels and two steel bridges, all of which were constructed between 1904 and 1907. These structures are known as Tunnel No. 1 (a 1,817-foot-long single tunnel that extends from milepost 1.33 to milepost 1.67), Tunnel No. 2 (a 1,086-foot-long double tunnel whose western portal has been partially infilled with brick and that extends from milepost 1.93 to milepost 2.14), 22nd Street Bridge (near milepost 1.70), and 23rd Street Bridge (near milepost 1.85).<sup>9</sup>

The district was identified in 2001 as part of the Planning Department’s Central Waterfront Survey and determined to be eligible for listing on the National Register under Criterion A because of its association with the development of the Central Waterfront, an area characterized by its mixed industrial and residential uses. As such, it is considered a Section 4(f) historic site. A period of significance was not identified; however, it can logically be presumed to be 1904–07, which corresponds to the construction of the bridges and tunnels. The structures were found to retain a high degree of integrity. Additionally, the tunnels and bridges were determined to be individually eligible for listing on the California Register;

---

determine if this property is in fact eligible for listing on the National Register and therefore a Section 4(f) historic site, confirmation should be requested from planning staff. See San Francisco Planning Department, *Showplace Square Historic Resource Survey Map*, accessed March 17, 2021, <https://sfplanning.org/resource/showplace-square-historic-resource-survey-map>.

<sup>9</sup> San Francisco Planning Department, State of California Department of Parks and Recreation (DPR) Series 523 Form-sets for the Bayshore Cutoff Tunnels No. 1 and 2 (P-38-004820), 22nd Street Bridge (P-38-004498), 23rd Street Bridge (P-38-004756), July 20, 2001.

because eligibility for listing under specific criterion/criteria was not specified, they are presumed to be individually eligible for listing under California Register Criterion 1 (events).<sup>10</sup>

#### **12.1.5.2 Alternative A1**

##### **Construction**

This alternative has the potential to result in direct and indirect construction impacts to the discontinuous Bridges and Tunnels Historic District. Alternative A1 would overlap with the boundaries of the district in one location: at the south end of Alternative A1 just south of 25th Street. Additionally, this alternative has the potential to result in new and/or increased vibration impacts to the aboveground historic resources located within the project corridor.

##### **Operation**

Alternative A1 includes excavation directly below Pennsylvania Avenue. This alternative would move the existing Caltrain alignment closer to a number of historic resources within the project corridor, particularly those located on Pennsylvania Avenue. This could result in new and/or increased operational vibration impacts to historic resources that are currently not impacted by Caltrain operations.

#### **12.1.5.3 Alternative A2**

##### **Construction**

Similar to Alternative A1, this alternative has the potential to result in direct and indirect construction impacts to the discontinuous Bridges and Tunnels Historic District and could have similar new and/or increased vibration impacts to the aboveground historic resources located within the project corridor.

##### **Operation**

Operational historic property impacts associated with Alternative A2 would be similar to those associated with Alternative A1.

#### **12.1.5.4 Alternative B1**

##### **Construction**

Similar to Alternatives A1 and A2, Alternative B1 could result in direct and indirect construction impacts to the discontinuous Bridges and Tunnels Historic District and could have similar new and/or increased vibration impacts to the aboveground historic resources located within the project corridor.

---

<sup>10</sup> Ibid.

## Operation

Operational historic property impacts associated with Alternative B1 would be similar to those associated with Alternatives A1 and A2.

### 12.1.5.5 Alternative B2

## Construction

Similar to Alternatives A1, A2, and B1, Alternative B2 could result in direct and indirect construction impacts to the discontinuous Bridges and Tunnels Historic District and could have similar new and/or increased vibration impacts to the aboveground historic resources located within the project corridor.

## Operation

Operational noise impacts associated with Alternative B2 would be similar to those associated with Alternatives A1, A2, and B1.

### 12.1.5.6 Alternative C

## Construction

Similar to all other alternatives, Alternative C could result in direct and indirect construction impacts to the discontinuous Bridges and Tunnels Historic District. Alignment C would overlap with the boundaries of the district in two locations: at the north end of Tunnel No. 1 (near Mariposa Street) and at 22nd Street (the location of the 22nd Street Bridge, which would not be impacted by the project). Additionally, this alternative also has the potential to result in new and/or increased vibration impacts to the aboveground historic resources located within the project corridor.

## Operation

Operational noise impacts associated with Alternative C would be similar to those associated with Alternatives A1, A2, B1, and B2.

## 12.2 Hazards and Hazardous Materials

The preliminary assessment of impacts associated with the presence of hazards<sup>11</sup> was based on a qualitative evaluation of the potential risks posed by the presence of former and existing hazardous sites in the project corridor. A potential impact would occur if a known hazardous site or contaminated soil or groundwater was encountered during construction, thereby exposing workers, general public, or the environment to hazardous materials. For discussion of potential impacts associated with unknown hazards associated with contaminated soil and groundwater, refer to the hydrology and geotechnical reports prepared for the PAX project (MJ/Slate, 2022a,b). This analysis considers construction impacts only;

---

<sup>11</sup> This analysis focuses on potential impacts associated with hazardous sites. Impacts associated with the use of hazardous materials during construction would likely be common to all alternatives and so are not discussed in this report but would be addressed in subsequent environmental review.



once constructed, the project would not affect or be affected by hazardous sites, and therefore operational impacts<sup>12</sup> are not discussed here.

The presence and potential release of hazardous materials and contaminants in subsurface soil and/or groundwater may affect the indoor or outdoor air, or air within a trench used by construction workers. Additionally, workers may be directly exposed to groundwater while performing activities in subsurface trenches or to contaminants in the subsurface soil and/or groundwater via incidental ingestion, dermal contact, and inhalation of vapor and dust particles.

The types of hazardous materials sites located in the project corridor consist of Leaking Underground Storage Tank (LUST) Cleanup Sites, various DTSC Cleanup Sites, and Cleanup Program Sites.<sup>13</sup> While closed sites would not likely pose a potential risk during construction, there are three open sites within the project corridor that could pose a risk during construction.

- ***Mission Bay – Mission Bay Redevelopment Area (Cleanup Program Site). Cleanup Status: Open – Site Assessment as of May 14, 2009.*** Environmental investigations conducted at the site indicate that the principal chemicals present are petroleum hydrocarbons associated with the former bulk petroleum operations. In 1999, a Risk Management Plan (Environ, 1999) was approved by the Regional Water Quality Control Board (RWQCB). In 2000, a covenant and environmental restriction (“deed restriction”) was executed for this property. Any construction activities within the boundaries of this property would require approval from the RWQCB prior to commencement (Catellus, 2000). Construction activities along the northern portions of all alignment alternatives (i.e., along the northern extent of Pennsylvania Avenue, 7th Street, and Townsend Street) would occur in proximity to this site and may encounter contaminated soil or groundwater, or may be planned within the boundaries of the existing covenant.
- ***Former Chevron Bulk Terminal (LUST Cleanup Site). Cleanup Status: Open – Remediation as of June 30, 2017.*** This site is the location of a former Standard Oil Company of California bulk storage and distribution facility, which was in operation from the late 1800s until 1974. The facility occupied an area bordered by 8th, Irwin, 7th, and Hubbell Streets. Multiple site investigations indicate the presence of petroleum hydrocarbons in the soil and groundwater at this site. Results of groundwater investigation conducted at the site also indicate the presence of light non-aqueous phase liquid (LNAPL; e.g., petroleum product floating on groundwater). Soil vapor investigations detected total petroleum hydrocarbons as gasoline (TPH-G) exceeding the residential and industrial shallow soil gas ESLs in three of six soil vapor probes (ARCADIS, 2014). Construction activities along the northern portions of all alignments (i.e., along 7th and

---

<sup>12</sup> This analysis assumes that any potential soil or groundwater contamination identified prior to construction would be avoided or mitigated, so as to not expose construction workers, the public, or the environment to any hazardous materials. Although, as discussed under construction impacts, there is a potential for the volatilization of contaminants in subsurface soil and/or groundwater, which could seep into air within the project tunnel during operation. However, it is assumed that vapor intrusion into the tunnel would be prevented through standard tunnel construction measures that would seal the tunnel from groundwater inflow.

<sup>13</sup> For location and additional details of specific sites, see Appendix L, the Pennsylvania Avenue Extension Study Environmental Constraints Analysis (ESA/MJ, 2022).

Townsend Streets) would occur in proximity to this site and may encounter contaminated soil or groundwater.

- ***Infoimage, Inc. (DTSC Evaluation Site). DTSC Status: Inactive – Needs Evaluation as of December 1, 1992.*** In 1992, lead and total petroleum hydrocarbons (TPH) were detected in soils within the fill materials at this site. Groundwater and surface water are indicated as possible pathways of contamination. In 1995, remediation was proposed, but it is unclear if any remediation was implemented; DTSC does not have a copy of a report confirming that remediation was implemented. In 1999, the site was reported to have been paved over. As of 1999, the site is in use as a storage rental facility. Further evaluation was recommended to determine if any remediation was implemented and whether additional work is needed (DTSC, 1999).

In addition, the Caltrain Yard is listed by the EPA as a small-quantity generator of hazardous waste and is on EPA databases. Contaminated soil cleanup has occurred at this site (TJPA Transbay Transit Center Supplemental EIS/EIR, 2015).

### **12.2.1 Alternative A1**

The Cleanup Program and LUST Cleanup Sites at the northern portion of Alternative A1 could impact construction activities as a result of potential soil and groundwater contamination. The DTSC Evaluation Site, near the intersection of Pennsylvania Avenue and 23rd Street, could also impact the construction of this alternative, as site records indicate the potential for soil and groundwater contamination. As the contamination at this site is unconfirmed, further investigation is recommended prior to excavation to accurately characterize the contamination at this site.

Additionally, as discussed above, there are 12 LUST Cleanup Sites located within the proposed route of this alignment, all of which are now closed. The records for these sites have been reviewed to determine if there is any indication that residual contamination is present and might be encountered during construction. Based on the review, records indicate that encountering any residual contamination from any of these closed sites is considered unlikely.

### **12.2.2 Alternative A2**

Impacts associated with this alignment would be similar to those associated with Alternative A1.

### **12.2.3 Alternative B1**

Although Alternative B1 is shorter than the previous two alignments, it could still be impacted by the presence of the Cleanup Program and LUST Cleanup Sites at the northern portion of this alignment described under Alternative A1. However, as this alignment would terminate north of the DTSC Evaluation Site, between 20th and 22nd Streets, it is unlikely to be affected by any potential contamination associated with this site. Similar to Alternative A1, the 12 LUST Cleanup Sites that were identified have been closed and would not result in any impacts associated with this alignment.

### **12.2.4 Alternative B2**

Impacts associated with this alternative would be similar to those associated with Alternative B1.

### 12.2.5 Alternative C

Impacts associated with this alternative would be similar to those associated with Alternatives B1 and B2. As with Alignments B1 and B2, because this alignment terminates north of the DTSC Evaluation Site, it is unlikely to be affected by any potential contamination associated with this site.

## 12.3 Environmental Justice

The evaluation of potential impacts associated with environmental justice considered whether project construction could have environmental impacts such as air pollution, noise, or risk of hazardous materials releases that would be experienced disproportionately by environmental justice populations. Because of the localized nature of the potential environmental impacts of the project, geographies within 0.25 mile of the potential project alignments were screened to identify potential environmental justice populations.<sup>14</sup>

During project operation, impacts on environmental justice populations would be beneficial and these populations would experience greater benefits than surrounding communities through improved local conditions such as reduction in ambient noise, congestion, and air emissions from idling vehicles. Project operation would be expected to result in a long-term localized reduction in vehicle exhaust emissions along the project alignment because of the reduction in vehicle congestion that currently exists along adjacent streets during train crossings. The project would result in beneficial operational noise impacts because of at-grade rail operations being relocated to within the proposed tunnel and the removal of at-grade crossings. Therefore, project operation is likely to result in beneficial impacts for surrounding communities with regard to air quality, noise, and hazardous materials and is not likely to result in any adverse impacts that could be disproportionately high or adverse for environmental justice populations. Because the operational beneficial impacts would be similar regardless of alternative, operational impacts are not discussed below for each of the alternatives. Environmental justice related to the 22nd Street Station will be addressed in the environmental document.

### 12.3.1 Alignment A1

Alignment A1 would include construction activities near several minority and low-income communities. Additionally, construction along the entire alignment would occur within and near census tracts with a high level of existing pollution burden with regard to diesel, traffic, cleanup sites, hazardous waste generators and facilities, and impaired water bodies. Project construction would result in short-term emissions of diesel particulate matter and other toxic air contaminants. This alternative would result in the most off-haul trips of excavated materials because of the dimensions of the tunnel and, therefore, the greatest impact to air quality. Under this alternative, sensitive receptors are located within 200 feet of the project alignment and would be exposed to elevated concentrations of toxic air contaminants during tunneling, which would pose a health risk to nearby communities. Because this alignment is located near low-income communities and communities with a high level of diesel pollution burden, construction of the proposed project has the potential to temporarily exacerbate high existing levels of diesel pollution burden.

---

<sup>14</sup> For additional details of environmental justice populations, see Appendix L, the Pennsylvania Avenue Extension Study Environmental Constraints Analysis (ESA/MJ, 2022).

As described in Section 12.2.1, LUST Cleanup Sites near the northern portion of the alignment and the DTSC Evaluation Site near the intersection of Pennsylvania Avenue and 23rd Street could result in soil and groundwater contamination, which could impact indoor or outdoor air quality. Because of the high existing level of groundwater threats, impaired water bodies, and hazardous waste generators and facilities in census tracts near this alignment, project construction has the potential to exacerbate existing pollution burden within the study area.

Under this alternative, construction noise impacts would be focused at the two tunnel portal ends. Because of high levels of existing ambient noise, the increase in noise levels is not expected to be significant. However, depending on the ultimate increase in noise levels at these locations and the proximity to low-income census tracts, noise impacts from construction of this alternative have the potential to temporarily impact nearby minority and low-income populations.

Along the project alignment, three of the census tracts are considered to be minority and/or low-income populations. Noise impacts from project construction have the potential to be disproportionately high and adverse for these populations as compared to other census tracts along the project alignment. Additionally, the potential for soil and groundwater contamination would be concentrated at the northern portion of the alignment, and this proximity could potentially result in a disproportionately high and adverse impact to an environmental justice population. Air quality impacts would occur along the alignment near all census tracts considered in this analysis. More detailed analysis of air quality impacts will be needed to identify whether any would be disproportionately high and adverse for the minority and low-income populations identified in this analysis as compared to the other census tracts along the alignment. Portions of the alignment—including portions of each of the minority and low-income census tracts identified—are located within the APEZ and would require special consideration to determine whether the project's activities would add a substantial amount of emissions to areas already adversely affected by poor air quality.

### **12.3.2 Alignment A2**

Construction of Alignment A2 would occur in the same area as Alignment A1 and would result in impacts to the same census tracts. Construction would be expected to result in approximately 23% fewer air emissions, similar noise impacts, and similar impacts with regard to hazardous materials as compared to Alignment A1. Therefore, impacts to environmental justice populations would likely be similar, but slightly reduced, as compared to Alignment A1.

### **12.3.3 Alignment B1**

Construction of Alignment B1 would occur in the same area as Alignment A1 and would result in impacts to the same census tracts. Construction would be expected to result in 30% fewer air emissions. Additionally, there would be no 19th Street ventilation shaft and the southernmost ventilation shaft would be under southbound I-280. Therefore, air quality impacts could be slightly reduced under this alternative as compared to Alignment A1. Additionally, this alignment would be expected to result in slightly reduced noise impacts, and similar impacts with regard to hazardous materials as compared to Alignment A1. Therefore, impacts to environmental justice populations would likely be similar, but slightly reduced, as compared to Alignment A1.

### **12.3.4 Alignment B2**

Construction of Alignment B2 would occur in the same area as Alignment A1 and would result in impacts to the same census tracts. Construction would be expected to result in approximately 54% fewer air emissions, similar noise impacts, and similar impacts with regard to hazardous materials as compared to Alignment A1. Therefore, impacts to environmental justice populations would likely be similar, but slightly reduced, as compared to Alignment A1.

### **12.3.5 Alignment C**

Construction of Alignment C would occur in the same area as Alignment A1 and would result in impacts to the same census tracts. Alternative C would result in lower emission concentrations near the north entry tunnel and ventilation shaft sites compared to emissions at the other ventilation shaft sites. This may result in reduced air quality impacts as compared to the other alternatives. This alignment would be expected to have similar impacts with regard to hazardous materials as compared to Alignment A1. Alignment C would have the greatest potential for noise impacts. Therefore, impacts to environmental justice populations would likely be similar, but with slightly higher potential for noise impacts, as compared to Alignment A1.

## **12.4 Major Issues**

The implementation of the PAX project would require major construction in a densely populated area of San Francisco. The construction and operation of the PAX project would likely result in some adverse effects on a range of resources. In general, these effects would be temporally limited to project construction, spatially limited to the project corridor, and could be mitigated with the implementation of a variety of measures. During operation, the project would provide a range of project benefits for the local community and adverse effects would be expected to be minimal.

With respect to each of the five alternatives, as all the alignments would be located within the same project corridor there would not be any substantial differences in project construction impacts between the alignments. The longer alignments (A1 and A2) would likely result in slightly more impacts because of the overall longer length of these alignments compared to the mid-length alignments (B1 and B2). Alternative C, which involves a shorter alignment and the use of cut-and-cover construction techniques, would result in the greatest construction impacts compared to the long and mid-length alignments as it would result in additional impacts on air quality and noise as a result of open construction as opposed to tunneling.

With respect to operation, there would be very few adverse effects associated with the project. Impacts on historic properties and residences associated with vibration could occur under any one of the alternatives, and would need to be evaluated further in subsequent environmental review. Generally, most project operational impacts would be beneficial. In operation the longer alternatives would offer greater environmental benefits as a result of the extended undergrounding of the existing Caltrain alignment compared to the three shorter alternatives.

## 12.5 Approval and Next Steps

The analysis of environmental constraints for the PAX project is intended to inform decision makers about the various resource considerations that should be taken into account as part of the project planning process. Project impacts and benefits would be evaluated in detail at the next stage of project environmental review, and the preliminary evaluation of environmental constraints will likely be used to focus the scope for future state and federal environmental review of the project pursuant to the California Environmental Quality Act (CEQA) and the National Environmental Policy Act (NEPA), respectively.

Mitigation measures that could be implemented to reduce and/or eliminate potential impacts on environmental resources are outlined in the PAX Environmental Constraints Analysis (ESA/MJ, 2022; Appendix L). These measures would be further developed during subsequent environmental review. As part of that subsequent review, guidance and regulations of a range of federal, state, and local agencies would be considered and implemented/complied with as appropriate.

## 13.0 Permitting

Construction of the PAX project would require completion of consultations with and issuance of authorizations and permits from various agencies with authority over the project. Preliminary review of the PAX project indicates that several consultations, authorizations, and permits may be required. Additional consultations, authorizations, and permits may be identified upon completion of CEQA and NEPA reviews.

### 13.1 Encroachment Permits

Construction and operation of the project would take place within Caltrans right-of-way associated with I-280. A **Caltrans Encroachment Permit** would be required to accommodate the project.

### 13.2 Air Quality Permits

Project construction would generate emissions from construction equipment and dust. Additionally, naturally occurring asbestos (NOA) and hazardous levels of toxic substances may be present in project area soils, which may pose an air quality or health risk if disturbed during construction. The project may require issuance of an **Authorization to Construct** or other applicable air quality permits from the Bay Area Air Quality Management District (BAAQMD).

### 13.3 Water Quality and Discharge Permits

Construction of the PAX project would require compliance with the National Pollutant Discharge Elimination System (NPDES) program, and the project would be required to comply with and append the **NPDES General Permit for Storm Water Discharges Associated with Construction and Land Disturbance Activities** (Order No. 2009-0009-DWQ and as amended by Orders 2010-0014-DWQ and 2012-0006-DWQ, or as updated at the time of project construction) as administered by the San Francisco Bay Regional Water Quality Control Board (RWQCB).

Coverage under the NPDES Construction General Permit is not required for projects in areas of San Francisco that drain to the combined sewer system. Projects in these areas must comply with the City of San Francisco's Construction Site Runoff Control Program and obtain a **Construction Site Runoff Control Permit** from the SFPUC prior to construction.

Although cursory review of the project area has not identified jurisdictional waters of the United States and State, and the need for associated permits is considered unlikely, if jurisdictional waters are present, then the project may require acquisition of permits as follows:

- Nationwide 404 permit pursuant to the federal Clean Water Act (CWA)
- 401 Clean Water Quality Certification pursuant to the federal CWA
- Waste discharge requirements pursuant to the California CWA

Construction of the project could encounter groundwater during construction, which would require dewatering. If dewatering is required during project construction, a **Batch Discharge Permit from the**

**San Francisco Department of Public Works** would be required for dewatering effluent discharge to the City of San Francisco's combined sewer system.

If dewatering would be required for operation of the project, then it is expected that permanent dewatering effluent would be discharged to the combined sewer system, and an **Industrial User Permit** would be required from the San Francisco Public Utilities Commission.

### **13.4 Noise Permits**

Nighttime construction may be required for the project. Per Article 29 Section 2908 of the San Francisco Police Code, construction activities in the public right-of-way that exceed the ambient noise level by 5 dBA is prohibited without a **Night Noise Permit** from the San Francisco Public Works Department.

### **13.5 Cultural Resources Consultations**

There are known historic resources in the project vicinity, and there is potential for buried prehistoric and historical-era cultural resources in the project corridor. As the project could affect historic resources, **consultation with the State Historic Preservation Office (SHPO)** pursuant to Section 106 of the National Historic Preservation Act, as Amended (NHPA) would be required to obtain concurrence on the effect finding.



## **14.0 Recommendations for Further Technical Studies**

### **14.1 General**

The objective of future phases of PAX studies will be to narrow the alignment alternatives and ultimately select a single alignment to design and construct. To this end, preliminary engineering and the environmental review process are expected to proceed concurrently to further define the scope of the project and obtain environmental clearance through the NEPA/CEQA process. To accomplish this, further technical studies will be required. The purpose of this section is to discuss a preliminary basis for the scope of such studies.

### **14.2 Environmental**

As stated in Section 12.5, project impacts and benefits would be evaluated in detail during the project environmental review, and the preliminary evaluation of environmental constraints will likely be used to focus the scope for future state and federal environmental review of the project pursuant to the California Environmental Quality Act (CEQA) and the National Environmental Policy Act (NEPA), respectively.

Mitigation measures that could be implemented to reduce and/or eliminate potential impacts on environmental resources are outlined in the PAX Environmental Constraints Report (Appendix L). These measures would be further developed during subsequent environmental review. As part of that subsequent review guidance and regulations of a range of federal, state, and local agencies would be considered and implemented/complied with as appropriate.

### **14.3 Traffic**

As construction configuration and methods are studied further, specific impacts related to ground treatment that include mid-alignment work activities and tunnel muck disposal at all possible disposal sites should be assessed. Updates to rail operations parameters should also be made if any changes arise after the conclusion of this phase of study.

In future stages of the project, the traffic impact analysis of the muck hauling should be reevaluated related to likely hauling hours and possible hauling restrictions. At the time this report it was assumed that muck would be removed evenly over a 24-hour period, including during the peak commute hours. A number of factors including landfill hours, cost, available staging, preclassification of excavation spoils, and community impacts could factor into muck hauling.

In addition, as stated in Section 12.1.1, evaluation of traffic impacts including evaluation of project-generated vehicle miles traveled would be undertaken during subsequent environmental analysis of the PAX project.

### **14.4 Geotechnical**

Investigations will include a robust geotechnical exploration program that will be accomplished by truck-mounted drill rigs drilling bores several inches in diameter to below planned tunnel depth to obtain soil, rock, and groundwater samples. Data to be obtained for the DTX project may be relevant and

incorporated into the PAX exploration program. As stated in Section 6.1, given the dense urban corridor and challenging geologic conditions anticipated along the PAX project corridor, it is anticipated that significant additional subsurface investigations will be needed to better characterize geotechnical conditions and to assist in evaluating the tunneling methods discussed in this report. As is normal practice, the results and interpretations of these investigations should be used to develop design parameters, model anticipated settlement due to project excavations, confirm selected or allowed excavation and support methods, select ground improvements and other mitigations, and set baselines for contract bidding. In the case of a twin bore alignment being selected, geotechnical investigation results should be used to select the pillar width between the bored tunnels, and the anticipated scope and location of ground improvement. The same should be performed for areas of low cover over the single bore tunnel.

## **14.5 Tunneling**

As mentioned in the prior section, mitigations for anticipated ground movements will be refined with regard to buildings, utilities, and other structures that could be impacted by tunneling operations. The determination and preliminary design of feasible ground support methods will progress so that community impacts can be determined for the CEQA process and accurate cost and schedules can be developed. Preliminary lining design is needed to confirm outside diameter of bored tunnels. Portal designs are needed to support selected excavation configurations. Spaceproofing of the underground works will involve sufficient preliminary design to ensure the dynamic envelope of trains, rail systems, emergency egress, ventilation, and all electrical and mechanical systems fits within tunnels, cross passages, adits, and shafts. Stability analysis should be undertaken where there is potential to affect major structures such as those owned by Caltrans and Caltrain. Requirements for performance-based and specification-based means and methods will need to be selected and prepared for inclusion in the contract documents.

## **14.6 Existing Utilities and Infrastructure**

Major existing known utilities should be investigated further, either in partnership with the SFPUC's planned projects or as separate investigations. Contingency design and planning should be included in all alternatives selected for further study because of unknowns. Potholing to verify as-built utility locations should be implemented as part of the detailed design process for PAX.

It will be critical to improve the accuracy of pile depth, location, and pile types used in construction of SFPUC's Division Street Sewer, the 7th Street Sewer, and the location of the future Folsom Street Sewer tunnel. All of these utilities impact the depth and location of the PAX tunnel, which will need to clear below pile tips to avoid TBM mining problems. Similarly, the I-280 deep foundation elements must be further defined near the tunnel alignments for the same reasons.

## **14.7 Rail/Systems**

Requirements for rail design parameters must be developed in partnership with Caltrain and CHSRA. Egress and ventilation design should be progressed with the involvement of the operators. Sequencing and scheduling of PAX interfaces where the project will tie-in to existing rail alignments will be important inputs for narrowing and selection of alignments.

## **14.8 ROW/Property**

Further analysis of right-of-way is needed, including additional sources for property value estimates. These would include comparable market sales, broker input and listing data, and appraisals or other estimates if they have been completed. Additional overall factors that will contribute to relevant ROW estimating should ultimately address issues such as potentially hazardous waste, severance damages, loss of business goodwill, relocation assistance, risk assessment and contingencies, etc. Categories such as these can be analyzed as the preliminary studies continue. In addition, projects in the pipeline with the City of San Francisco should be included in the ROW analysis.

## **14.9 Risk**

The risk matrix should be updated as a part of the decision-making process during the next phase of work.

## 15.0 Conclusion

Three viable PAX alternative alignments have been developed, two of which have sub-options for a total of five alternative configurations, as follows:

- **Alternative A1/A2: Long Alignment** that bypasses the existing 22nd Street Station. Alternative A1 as a single large (42-foot outside diameter) 1.5-mile-long TBM bored tunnel with both northbound and southbound tracks in a single tunnel. Alternative A2 is two smaller (26-foot outside diameter) 1.5-mile-long TBM bored tunnels, each with a single track. This alternative likely results in the decommissioning of the existing 22nd Street Station.
- **Alternative B1/B2: Mid-Length Alignment** connecting tunnels from DTX to just north of the existing 22nd Street Station, which would be modified for continued use. Alternative B1 is a single large (42-foot outside diameter) 0.9-mile-long TBM bored tunnel with both northbound and southbound tracks in a single tunnel. Alternative B2 is two smaller (26-foot outside diameter) 0.9-mile long TBM bored tunnels each with a single track. Both B1 and B2 have short SEM sections, 600 feet to 700 feet long, connecting TBM bored tunnel to existing track. This alternative allows use of the existing 22nd Street Station, with modifications.
- **Alternative C: Short Alignment – Split Tunnels** is a hybrid with the northbound track in a new cut-and-cover tunnel under I-280 and a single smaller (26-foot outside diameter) 1.0-mile-long TBM bored tunnel containing the southbound track. The concept allows continued use of the existing 22nd Street Station, with modifications.

The alternatives were scored using an evaluation framework of 23 criteria grouped into five separate categories that were selected to provide a broad spectrum analysis of program, environmental, community, and engineering factors. The results were as shown in Table 15-1, with the higher number reflecting a more favorable rating:

**Table 15-1. Preliminary Evaluation Score Results for Alternatives**

| Alternative            | A1  | A2  | B1  | B2  | C   |
|------------------------|-----|-----|-----|-----|-----|
| Overall Weighted Score | 2.2 | 2.1 | 2.1 | 2.1 | 1.9 |

The results show relatively equivalent scoring across all alternatives, with Alternative A edging slightly ahead and Alternative C behind the others. Alternative C offers some advantages, such as the lowest construction cost and the ability to use the existing 22nd Street Station. However, this study revealed that Alternative C has shortcomings (including construction risks associated with the northbound track cut-and-cover section, as well as significant impacts to Caltrain operations during construction) when compared to the other alternatives. Alternative C scored lowest for meeting project goals, construction, and environmental impacts. It is noted that Alternatives B1 and B2 offer the PAX alignment similar overall benefits as Alternative C with respect to making use of the existing 22nd Street Station.

In considering the Alternative A Alignments and the Alternative B Alignments, it is evident that the overall scoring is nearly equal, with the single bore tunnels scoring slightly higher than, or the same as, their twin bore counterparts. The further studies recommended in this report will provide guidance as to the best path forward with respect to selecting single versus twin bore. Consideration should be given in

future phases to whether both single and twin bore tunnels can be offered as options for bidding tunnel contractors or design-build teams. The advantage in this regard, assuming all other factors are equal, is to let the marketplace determine the least expensive, least risky, and most constructible alternative. Including the twin bore configuration is likely to enlarge the pool of potential qualified bidders, thereby increasing competition for the project. The design and location of a station within the PAX footprint, and the selected project delivery methods, will be important factors in making this decision.

The primary driver here will be the decision-making process of determining the need for and the location of a future station along or near the PAX alignment. A decision to make use of the existing 22nd Street Station effectively eliminates the A Alignments unless a new subsurface station is planned, and the project would then determine whether B1, B2, or C is the most viable alternative. Alternatively, if it is decided that the existing 22nd Street Station can be replaced, then all alternatives are open to selection. In reviewing the Evaluation Framework Scoring, it is evident that the A Alignment Alternatives offer greater benefits for achieving project goals (including street connectivity, seismic performance, rail operations, and surface safety) than do the B or C Alternatives. Further, construction criteria scoring (which includes constructability, geologic profile, disruption to existing rail operations, and access/laydown) favors the A Alignments over the B Alignments.

In summary, the recommendation for the next phase is to include a focus on consideration of a rail station in or near the PAX alignment, as this is most likely the single greatest factor impacting PAX alignment selection.

Section 14.0 of this report summarizes recommendations for further studies. As outlined below, there are critical aspects of the PAX project that stand out as a higher level of priority requiring study early in the next phase, as their outcome has a significant impact on viability of the alternatives.

1. The DTX/PAX/Railyards interface needs to be further advanced and a sequencing/phasing plan developed that will allow DTX to be brought on line for revenue service while PAX design and construction proceed concurrently.
2. The twin bore arrangement for Alternatives A2 and B2 should be studied further in the 7th Street area where the two tunnels pinch together because of the I-280 foundation elements and privately held land. The feasibility of twin bore tunneling in this area was confirmed in this study; however, it was determined that ground modification, which carries significant cost and surface impacts, is expected to be necessary. The extent of ground modification and impacts at the surface on 7th Street should be further studied to fully understand cost, schedule, and community/traffic impacts.
3. The single bore tunnel for Alternative A1 under Pennsylvania Avenue and the single bore tunnel for Alternative B1 under 7th Street and Pennsylvania Avenue have an area of low ground cover. As with the closely spaced twin bore tunnels, ground modification may be required in Pennsylvania Avenue, which would have surface impacts. The need for and potential extent of this work should be evaluated further.
4. A concerted effort should be made to further map existing utilities and infrastructure early in the next phase, particularly those that have significant impacts on the alignment selection and locations. High priority should be placed on determining accurate as-built locations of the I-280 foundations and the SFPUC Division Street Sewer and planned Folsom Street Sewer tunnel.

These structures will have significant impacts on both vertical and horizontal alignments. Coordination with DTX is also recommended for proposed utility relocations along 6th Street as these relocations may impact the PAX alignment and other SFPUC sewer improvements along Berry Street (including the Folsom Sewer tunnel).

5. Conceptual engineering performed in this study for the existing 22nd Street Station area for Alternatives B1, B2, and C is very preliminary in nature. If it is decided to proceed with retaining use of the existing 22nd Street Station, the concept for the following project elements needs to be advanced:
  - a. Modifications to the existing station;
  - b. Mining approach from the end of TBM bored tunnels into the existing track and existing Caltrain Tunnel 1 located north of the station;
  - c. The interference between existing I-280 foundations and preferred new rail alignment just north of the station and south of Tunnel 1;
  - d. Modifications to the existing 22nd Street bridge overpasses;
  - e. Retaining wall on the west side of the station and ROW issues in this area;
  - f. Condition of the existing abandoned Tunnel 2 and work required to reuse this tunnel; and
  - g. Caltrain and blended service operational requirements for this area such as the need for track to allow through trains to bypass trains stopped at the station. Additionally, further collaboration with Caltrain with regard to construction phasing is important to confirming viability of the alternatives, especially Alternative C, which would require a significant interruption to Caltrain service during construction.
6. Conceptual engineering was not performed in this study for a potential new subsurface station, mid-alignment for Alternative A1/A2. Future phases of work will need to examine this design concept and impact to PAX design, construction, and operations.

## 16.0 References

ARCADIS U.S. Inc. 2014. Site Mitigation and Investigation Work Plan, October 31, 2014. From Jacob Henry of Arcadis to Stephanie K.J. Cushing of City and County of San Francisco, Dept. of Public Health.

California Department of Toxic Substances Control (DTSC). 1999. EPA Region IX Site Screening/Prioritization Checklist.

Catellus Development Corporation. 2000. *Agreement: Covenant and Environmental Restriction on Property*, February 23, 2000. For property known as “Mission Bay Development Area.”

City and County of San Francisco (CCSF). 2018a. San Francisco Neighborhoods Socio-Economic Profiles American Community Survey 2012-2016. Prepared by the San Francisco Planning Department. [https://default.sfplanning.org/publications\\_reports/SF\\_NGBD\\_SocioEconomic\\_Profiles/2012-2016\\_ACS\\_Profile\\_Neighborhoods\\_Final.pdf](https://default.sfplanning.org/publications_reports/SF_NGBD_SocioEconomic_Profiles/2012-2016_ACS_Profile_Neighborhoods_Final.pdf), accessed February 2021.

City and County of San Francisco (CCSF). 2018b. Rail Alignment Benefits Study, Final Technical Report. Prepared by CH2M Hill for the San Francisco Planning Department. September 2018.

City and County of San Francisco (CCSF). 2018c. Rail Alignment Benefits Study, Executive Summary Report. Prepared by the San Francisco Planning Department. September 2018.

Department of Transportation Act. Congress Public Law 89-670, Oct. 15, 1966, 80 United States Statutes at Large 931.

Environ. 2019. *Risk Management Plan for the Mission Bay Project Area, San Francisco, California*, May 11, 1999.

Environmental Science Associates and McMillen Jacobs Associates (ESA/MJ). 2022. Pennsylvania Avenue Extension Study Environmental Constraints Analysis. Prepared for the San Francisco County Transportation Authority, June 2022.

Federal Reserve Bank, St. Louis. n.d. Federal Reserve Economic Data (FRED). Accessed 2021. <https://fred.stlouisfed.org/>.

Federal Transit Administration (FTA). 2018. Transit Noise and Vibration Impact Assessment Manual, FTA Report No. 0123. Washington DC: U.S. Department of Transportation.

Herrenknecht. n.d. EPB Shield. Accessed March 2021. <https://www.herrenknecht.com/en/products/productdetail/epb-shield/>.

Itasca Consulting Group. 2016. Fast Lagrangian Analysis of Continua in Two Dimensions (FLAC), Version 7.0. Minneapolis, MN: Itasca Consulting Group.

McMillen Jacobs Associates and Slate Geotechnical Consultants (MJ/Slate). 2022a. Pennsylvania Avenue Extension Study, Hydrology Study. Prepared for the San Francisco County Transportation Authority, September.

McMillen Jacobs Associates and Slate Geotechnical Consultants (MJ/Slate). 2022b. Pennsylvania Avenue Extension Study, Geotechnical Study Report, prepared for the San Francisco County Transportation Authority, September.

Meyer, Jack, and Paul Brandy. 2019. *Geological Assessment and Prehistoric Site Sensitivity Model for the City and County of San Francisco, California*. Prepared by Far Western Anthropological Research Group for San the Francisco Planning Department, Environmental Planning Division.

Olmsted, Roger R., and T.H. Watkins. 1968. *Here Today: San Francisco's Architectural Heritage* (Morley Baer, photographer). San Francisco, CA: Chronicle Books.

San Francisco Municipal Transportation Agency (SFMTA). 2016. 2015 Transportation Factsheet. Accessed February 2021. <https://www.sfmta.com/reports/2015-transportation-fact-sheet>.

Transbay Joint Powers Authority (TJPA). 2017. Tunnel Options Study for the Downtown Rail Extension Project, Task 7.1 (Final Version, November 8, 2017). Prepared by the Parsons Transportation Group in Association with McMillen Jacobs Associates.

Transbay Joint Powers Authority (TJPA). 2015. Draft Supplemental Environmental Impact Statement/Environmental Impact Report (Final Version, December 2015).

Transportation Research Board (TRB). 2010. *Estimating Soft Costs for Major Public Transportation Fixed Guideway Projects*. Transit Cooperative Research Program (TCRP) Report 138. Washington, DC: TRP.

U.S. Bureau of Labor Statistics. n.d. Data Tools. Series Report. Accessed February 2021. <http://data.bls.gov/cgi-bin/srgate>.